



# RX-V495RDS

*Natural Sound AV Receiver*

*Ampli-Tuner Audio-Video*

**OWNER'S MANUAL  
MODE D'EMPLOI  
BEDIENUNGSANLEITUNG  
BRUKSANVISNING  
MANUALE DI ISTRUZIONI  
MANUAL DE INSTRUCCIONES  
GEBRUIKSAANWIJZING**

**SUPPLIED ACCESSORIES**  
**ACCESSOIRES FOURNIS**  
**MITGELIEFERTE ZUBEHÖRTEILE**  
**MEDFÖLJANDE TILLBEHÖR**  
**ACCESSORI IN DOTAZIONE**  
**ACCESORIOS INCLUIDOS**  
**BIJGELEVERDE ACCESSOIRES**

- After unpacking, check that the following parts are included.
- Après le déballage, vérifier que les pièces suivantes sont incluses.
- Nach dem Auspacken überprüfen, ob die folgenden Teile vorhanden sind.
- Kontrollera efter uppäckningen att följande delar finns med.
- Verificare che tutte le parti seguenti siano contenute nell'imballaggio dell'apparecchio.
- Desembalar el aparato y verificar que los siguientes accesorios están en la caja.
- Controleer na het uitpakken of de volgende onderdelen voorhanden zijn.

- Indoor FM Antenna
- Antenne FM intérieure
- UKW-Innenantenne
- Inomhus-FM-antenn
- Antenna FM interna
- Antena FM interior
- FM-binnenantenne

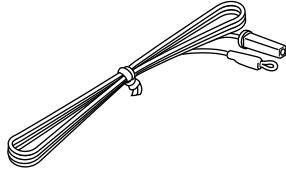

- AM Loop Antenna
- Cadre-antenne AM
- MW-Rahmenantenne
- AM-ramantenn
- Antenna AM ad anello
- Antena de cuadro de AM
- AM-raamantenne

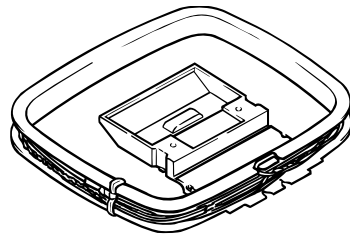

- 75-ohm/300-ohm antenna adapter (U.K. model only)
- Adaptateur d'antenne 75 ohms/300 ohms (Modèle Royaume-Uni seulement)
- 75-Ohm/300-Ohm Antennenstecker (nur Großbritannien-Modell)
- 75 ohm/300 ohm antennadapter (gäller endast modellerna för Storbritannien)
- Adattatore per antenna da 75 e 300 ohm (Soltanto il modello per la Gran Bretagna)
- Adaptador de antena de 75-ohmios/300-ohmios (Sólo el modelo para el Reino Unido)
- 75 ohm/300 ohm antenneadapter (Alleen modellen voor Verenigd Koninkrijk)

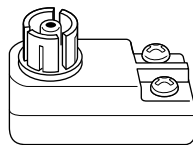

- Batteries (size AAA, R03, UM-4)
- Piles (taille AAA, R03, UM-4)
- Batterien (Größe AAA, R03, UM-4)
- Batterier (storlek AAA, R03, UM-4)
- Batterie (formato AAA, R03, UM-4)
- Pilas (tamaño AAA, R03, UM-4)
- Batterijen (maat AAA, R03, UM-4)

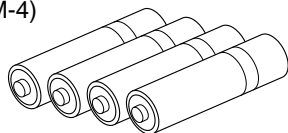

- Remote control transmitter
- Télécommande
- Fernbedienung
- Fjärrkontroll
- Telecomando
- Transmisor de control remoto
- Afstandsbediening

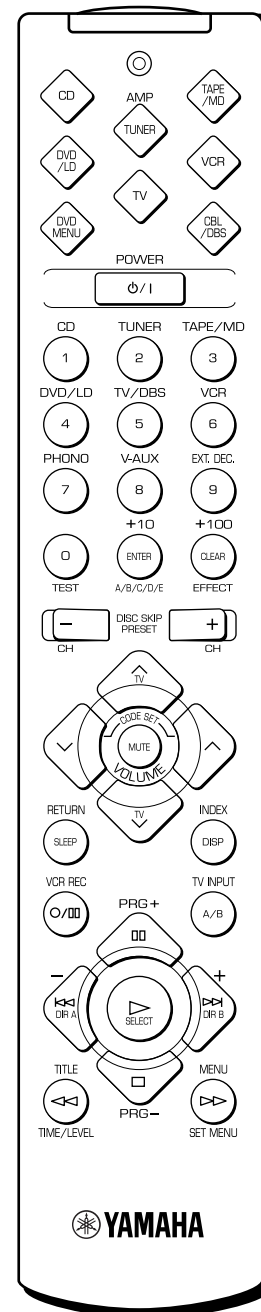

# FEATURES

- **5-Channel Power Amplification**  
**Minimum RMS Output Power**  
**<0.04% THD, 20 Hz – 20 kHz>**  
**Main: 60 W + 60 W (8 Ω)**  
**Center: 60 W (8 Ω)**  
**Rear: 60 W + 60 W (8 Ω)**
- **Digital Sound Field Processor**
- **Dolby Digital Decoder**
- **Dolby Pro Logic Surround Decoder**
- **CINEMA DSP: Theater-like Sound Experience by the Combination of Dolby Surround and YAMAHA DSP Technology**
- **6-Channel External Decoder Input for DTS and other future formats**
- **Automatic Input Balance Control for Dolby Pro Logic Surround**
- **Test Tone Generator for Easier Speaker Balance Adjustment**
- **Speaker Output Mode Changing Capability**
- **40-Station Random Access Preset Tuning**
- **Automatic Preset Tuning**
- **Preset Station Shifting Capability (Preset Editing)**
- **Video Signal Input/Output Capability**
- **SLEEP Timer**
- **Universal Remote Control Transmitter with Preset Manufacturer Codes**

# CONTENTS

SUPPLIED ACCESSORIES .....	2	● <b>Information about DSP</b>	
FEATURES .....	3	USING THE DIGITAL SOUND FIELD	
CAUTION .....	4	PROCESSOR (DSP) .....	41
● <b>Introduction</b>		● <b>Advanced Information</b>	
FEATURES OF SOUND EFFECTS .....	5	ADJUSTMENTS	
CONTROLS AND THEIR FUNCTIONS .....	7	IN THE "SET MENU" MODE .....	47
● <b>Preparation</b>		● <b>Remote Control Transmitter</b>	
SPEAKER SETUP .....	12	REMOTE CONTROL TRANSMITTER .....	49
CONNECTIONS .....	14	SETUP CODES .....	56
ADJUSTMENTS		TROUBLESHOOTING .....	57
BEFORE USING THIS UNIT .....	21	SPECIFICATIONS .....	59
● <b>Basic Operation</b>		LIST OF MANUFACTURER'S CODES .....	411
BASIC OPERATIONS .....	26		
TUNING OPERATIONS .....	30		
RECEIVING RDS STATIONS .....	35		
SETTING THE SLEEP TIMER .....	40		

# CAUTION: READ THIS BEFORE OPERATING YOUR UNIT.

1. To assure the finest performance, please read this manual carefully. Keep it in a safe place for future reference.
2. Install this unit in a cool, dry, clean place – away from windows, heat sources, sources of excessive vibration, dust, moisture and cold. Avoid sources of humming (transformers, motors). To prevent fire or electrical shock, do not expose the unit to rain or water.
3. Never open the cabinet. If something drops into the set, contact your dealer.
4. Do not use force on switches, controls or connection wires. When moving the unit, first disconnect the power plug and the wires connected to other equipment. Never pull the wires themselves.
5. The openings on the unit cover assure proper ventilation of the unit. If these openings are obstructed, the temperature inside the unit will rise rapidly. Therefore, avoid placing objects against these openings, and install the unit in a well-ventilated area to prevent fire and damage.  
  
Be sure to allow a space of at least 20 cm behind, 20 cm on the both sides and 30 cm above the top panel of the unit to prevent fire and damage.
6. The voltage used must be the same as that specified on this unit. Using this unit with a higher voltage than specified is dangerous and may result in fire or other accidents. YAMAHA will not be held responsible for any damage resulting from use of this unit with a voltage other than specified.
7. Digital signals generated by this unit may interfere with other equipment such as tuners, receivers or TVs. Move this unit farther away from such equipment if interference is observed.
8. Always set the VOLUME control to “∞” before starting the audio source play. Increase the volume gradually to an appropriate level after playback has been started.
9. Do not attempt to clean the unit with chemical solvents; this might damage the finish. Use a clean, dry cloth.
10. Be sure to read the “TROUBLESHOOTING” section regarding common operating errors before concluding that the unit is faulty.
11. When not planning to use this unit for long periods of time (ie., vacation, etc.), disconnect the AC power plug from the wall outlet.
12. To prevent lightning damage, disconnect the AC power plug and disconnect the antenna cable when there is an electrical storm.
13. Grounding or polarization – Precautions should be taken so that the grounding or polarization of an appliance is not defeated.
14. AC outlet  
Do not connect audio equipment to the AC outlet on the rear panel if that equipment requires more power than the outlet is rated to provide.

## For U.K. customers

If the socket outlets in the home are not suitable for the plug supplied with this appliance, it should be cut off and an appropriate 3 pin plug fitted. For details, refer to the instructions described below.

**Note:** The plug severed from the mains lead must be destroyed, as a plug with bared flexible cord is hazardous if engaged in a live socket outlet.

## Special Instructions for U.K. Model

### IMPORTANT

THE WIRES IN MAINS LEAD ARE COLOURED IN ACCORDANCE WITH THE FOLLOWING CODE:

Blue: NEUTRAL

Brown: LIVE

As the colours of the wires in the mains lead of this apparatus may not correspond with the coloured markings identifying the terminals in your plug, proceed as follows:  
The wire which is coloured BLUE must be connected to the terminal which is marked with the letter N or coloured BLACK. The wire which is coloured BROWN must be connected to the terminal which is marked with the letter L or coloured RED.  
Making sure that neither core is connected to the earth terminal of the three pin plug.

This unit is not disconnected from the AC power source as long as it is connected to the wall outlet, even if this unit itself is turned off. This state is called the standby mode. In this state, this unit is designed to consume a very small quantity of power.

# FEATURES OF SOUND EFFECTS

## Introduction

---

Welcome to the exciting world of digital home entertainment. This unit is one of the most complete and advanced AV receivers available. Some of the more advanced features may not be familiar to you, but they are easy to use. State-of-the-art technologies such as Dolby Digital and Digital Theater Systems (DTS) may be new to your home, but you have probably experienced the amazing realism they bring to feature films in theaters around the world.

To make the listening experience even more enjoyable, this unit includes a number of exclusive, digitally created listening environments known as digital sound fields. Choosing a sound field program is like transporting yourself to such venues as an outdoor arena, a European church, or a cozy jazz club. Take some time now to read more about these features and enjoy the new experiences this unit brings to your home theater.

## Digital Sound Field Processing

---

What is it that makes live music so good? Today's advanced sound reproduction technology lets you get extremely close to the sound of a live performance, but the chances are that you'll still notice something missing — the acoustic environment of the live concert hall. Extensive research into the exact nature of the sonic reflections that create the ambience of a large hall has made it possible for YAMAHA engineers to bring you this same sound to your listening room, so you'll feel all the sound of a live concert.

Furthermore, our technicians, armed with sophisticated measuring equipment, have even made it possible to capture the acoustics of a variety of actual concert halls, theaters, etc. from around the world, to allow you to accurately re-create any one of these live performance environments, all in your own home.

## Dolby Pro Logic Surround

---

Dolby Surround has been used in movie theaters since the mid-seventies. It has also been available in home entertainment systems since the late eighties and continues to be a popular format for home theater systems. It uses four discrete channels and five speakers to reproduce realistic and dynamic sound effects: two main channels (left and right), a center channel for dialog, and a rear channel for special sound effects. The rear channel reproduces sound within a narrow frequency range.

Most video tapes and laser discs include Dolby Surround encoding, as do many TV and cable broadcasts. The Dolby Pro Logic Surround decoder built into this unit employs a digital signal processing system that stabilizes each channel for even more accurate sound positioning than is available with standard analog processors.

## Dolby Digital

---

The built-in Dolby Digital decoder leads you into a totally new sound experience.

Dolby Digital is a new generation of multi-channel digital audio technology, or the newest spatial sound processing format developed for 35 mm-film movies by employing a new kind of low bit-rate audio coding.

Dolby Digital is a digital surround sound system that provides completely independent multi-channel audio to listeners. In multi-channel form, Dolby Digital provides 5 full-range channels in what is sometimes referred to as a "3/2" configuration: three front channels (left, center and right), plus two surround channels. A sixth bass-only effect channel is also provided for output of LFE (low frequency effect), or low bass effects that are independent of other channels. This channel is counted as 0.1, thus giving rise to the term 5.1 channels in total.

Compared to Dolby Pro Logic, which is referred to a "3/1" system (left front, center, right front and just one surround channel), Dolby Digital features two surround channels, called stereo or split surrounds, each offering the same full-range fidelity as the three front channels.

Sound of wide dynamic range reproduced by the 5 full-range channels provides listeners with excitement that has never been experienced before. Precise sound orientation by discrete digital sound processing expands the realism that the original movie possesses.

LD and DVD are home audio/video program source that could benefit from Dolby Digital. In the near future, Dolby Digital will also be applied to DBS, CATV and HDTV. The ongoing release of Dolby Digital theatrical films now underway will provide an immediate source of Dolby Digital encoded video software.



Manufactured under license from Dolby Laboratories. "Dolby", "Pro Logic" and the double-D symbol are trademarks of Dolby Laboratories.

The following original functions make the surround-sound effect of Dolby Digital become the most suitable for your audio system and the listening conditions.

## CINEMA DSP: Dolby Surround + DSP

The Dolby Surround sound system shows its full ability in a large movie theater, because movie sounds are originally designed to be reproduced in a large movie theater using many speakers. It is difficult to create a sound environment similar to that of a movie theater in your listening room, because the room size, materials of inside walls, the number of speakers, etc. of your listening room are very different from those of a movie theater.

YAMAHA DSP technology made it possible to present you with nearly the same sound experience as that of a large movie theater in your listening room by compensating for the lack of presence and dynamics in your listening room with its original digital sound fields combined with the Dolby Surround sound system.

### CINEMA DSP

The YAMAHA "CINEMA DSP" logo indicates those programs that are created by the combination of Dolby Surround and YAMAHA DSP technology.

#### Dolby Pro Logic + 2 Digital Sound Fields

Digital sound fields are created on the presence side and the rear surround side of the Dolby Pro Logic Surround-decoded sound field, respectively. They create a wide acoustic environment and emphasize the surround effect in the room, letting you feel as much presence as if you are watching a movie in a popular Dolby Stereo theater.

This combination is available when the **DOLBY PRO LOGIC ENHANCED/DOLBY DIGITAL ENHANCED, 70 mm MOVIE THEATER/DIGITAL MOVIE THEATER** or **TV SPORTS** sound field program is selected, and the input signal of source is analog, PCM audio or encoded with Dolby Digital sound in 2-channel.

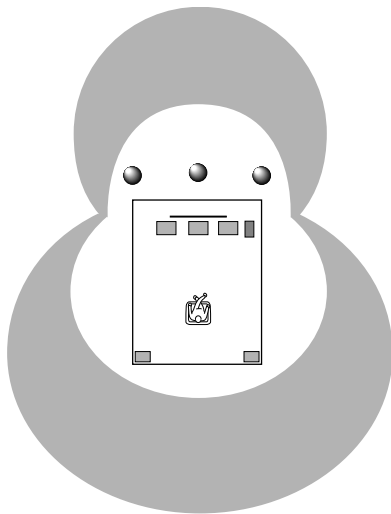

#### Dolby Digital + 3 Digital Sound Fields

Digital sound fields are created on the presence side and the independent left and right surround sides of the Dolby Digital-decoded sound field, respectively. They create a wide acoustic environment and strong surround effect in the room without losing high-channel separation. With the wide dynamic range of Dolby Digital sound, this sound field combination lets you feel as if you are watching a movie in the newest Dolby Stereo Digital theater. This will be the most ideal home theater sound at the present time.

This combination is available when the **DOLBY PRO LOGIC ENHANCED/DOLBY DIGITAL ENHANCED, 70 mm MOVIE THEATER/DIGITAL MOVIE THEATER** or **TV SPORTS** sound field program is selected, and the input signal of source is encoded with Dolby Digital sound (except in 2-channel).

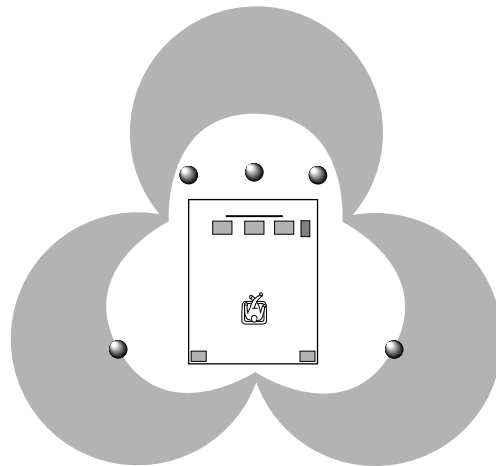

# CONTROLS AND THEIR FUNCTIONS

## FRONT PANEL

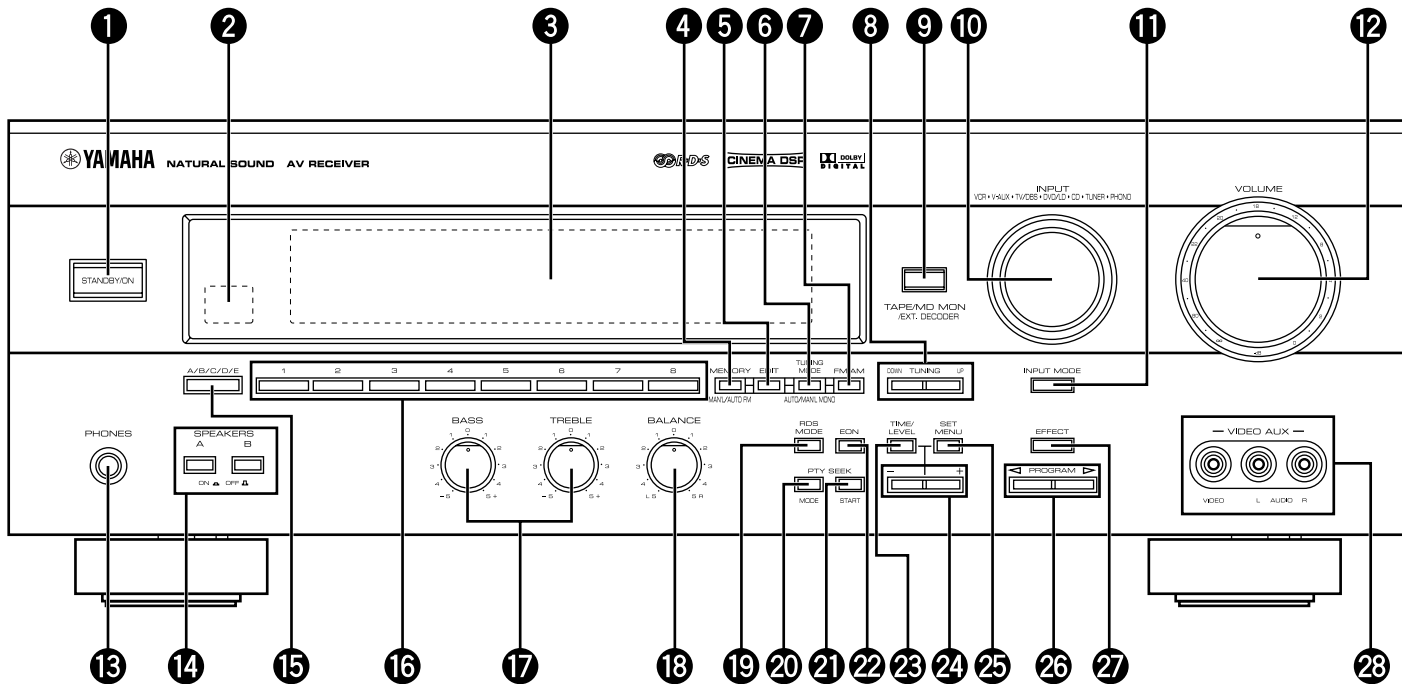

### 1 STANDBY/ON

Press this switch to turn on the power to this unit. Press it again to set this unit to the standby mode.

#### Standby mode

In this state, this unit consumes a very small quantity of power to receive infrared-signals from the remote control transmitter.

### 2 Remote control sensor

This receives signals from the remote control transmitter.

### 3 Display

This shows various information. (Refer to page 9 for details.)

### 4 MEMORY (MAN'L/AUTO FM)

Press this button to store the broadcasting stations. When this button is pressed and held for more than three seconds, the automatic preset tuning begins.

### 5 EDIT

This button is used to exchange the assignment of two preset stations with each other.

### 6 TUNING MODE (AUTO/MAN'L MONO)

Press this button to switch the tuning mode to automatic or manual. To select the automatic tuning mode, press this button so that the "AUTO TUNING" indicator lights up on the display. To select the manual tuning mode, press this button so that the "AUTO TUNING" indicator goes off.

### 7 FM/AM

Press this button to switch the reception band to FM or AM.

### 8 TUNING UP/DOWN

This button is used for tuning. Press the UP side to tune in to higher frequencies, and press the DOWN side to tune in to lower frequencies.

### 9 TAPE/MD MON / EXT. DECODER

Press this button to play a tape or an MD. The "TAPE/MD MON" indicator lights up on the display. When you press the button next, the "TAPE/MD MON" indicator goes off, "EXT. DECDR" appears on the display and you can play the signal connected to the **EXTERNAL DECODER INPUT** terminals.

### 10 INPUT

Turn this selector to select the program source (VCR, VIDEO AUX, TV/DBS, DVD/LD, CD, TUNER, PHONO) to listen to or watch.

The name of the selected program source appears on the display.

### 11 INPUT MODE

This button switches the DVD/LD and TV/DBS input signal mode (AUTO/ANALOG).

### 12 VOLUME

This control is used to raise or lower the volume level.

### 13 PHONES jack

When you use headphones, connect the headphones to the **PHONES** jack. You can listen to the sound to be output from the main speakers through the headphones.

When using headphones only, set both **SPEAKERS A** and **B** to the OFF position and switch off the digital sound field processor (so that no DSP program name appears on the display) by pressing **EFFECT**.

### 14 SPEAKERS

Set **A** or **B** (or both **A** and **B**) to the ON position for the main speaker system (connected to this unit) that you want to use. Set the button(s) for the main speaker system you don't want to use to the OFF position.

### 15 A/B/C/D/E

Press this button to select one of a group (A to E) of preset stations.

### 16 Preset station number selector

Each of these buttons selects a preset station number (1 to 8).

### 17 Tone controls

These controls are only effective for the sound from the main speakers.

#### BASS

Use this control to increase or decrease the low-frequency response. The "0" position produces flat response.

#### TREBLE

Use this control to increase or decrease the high-frequency response. The "0" position produces flat response.

### 18 BALANCE

This control is only effective for the sound from the main speakers.

Turn the control to adjust the balance of the output volume to the left and right speakers to compensate for sound imbalance caused by the speaker location or listening room conditions.

### 19 RDS MODE

When an RDS station is received, pressing this button changes the display into the PS mode, PTY mode, RT mode and/or CT mode (if the station employs those RDS data services) in turn.

### 20 PTY SEEK MODE

When this button is pressed, the unit is set in the PTY SEEK mode.

### 21 PTY SEEK START

Press this button to begin searching for a station after the desired program type has been selected in the PTY SEEK mode.

### 22 EON

Press this button to select the desired program type (NEWS, INFO, AFFAIRS, SPORT) when you want to call a radio program of that type automatically.

### 23 TIME/LEVEL

Press this button to select the item in the TIME/LEVEL mode.

### 24 +/-

These buttons are used to adjust the settings of the SET MENU mode and the TIME/LEVEL mode. In the TIME/LEVEL mode, press **+** to increase the delay time or speaker output level. Press **-** to decrease the delay time or speaker output level.

### 25 SET MENU

Press this button to select functions in the SET MENU mode.

### 26 PROGRAM selector

Press **<** or **>** to select the DSP program.

The name of the selected program appears on the display.

### 27 EFFECT

This button switches on and off the output from the center and rear speakers so that the sound becomes the normal 2-channel.

\* Even if the output from the center and rear speakers is off, when the Dolby Digital is decoded, the signals on all channels are distributed to the main channels and output from the main speakers.

### 28 VIDEO AUX terminals

Connect an auxiliary video or audio input source unit such as a camcorder to these terminals. The source connected to these terminals can be selected by **INPUT**.



## DISPLAY PANEL

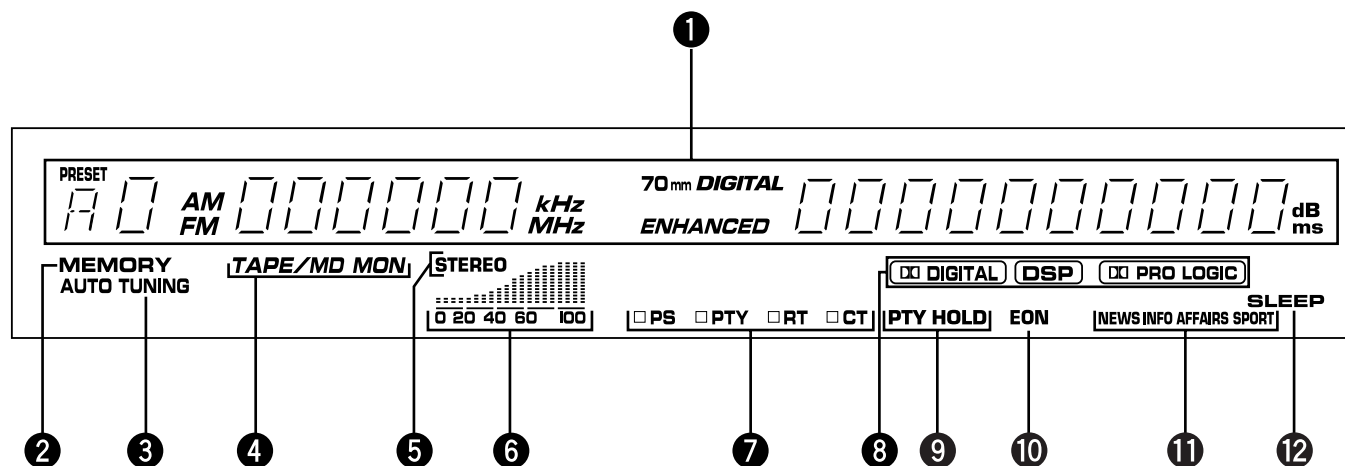

### 1 Multi-information display

This displays various information, for example the station frequency, preset station number and name of the selected program source.

### 2 MEMORY indicator

When **MEMORY** is pressed, this indicator flashes for about five seconds. During this period, the displayed station can be stored in the memory.

### 3 AUTO TUNING indicator

This lights up when the unit is in the automatic tuning mode.

### 4 TAPE/MD MON indicator

This lights up when the tape deck (or MD recorder, etc.) is selected as the program source by pressing **TAPE/MD MON / EXT. DECODER** on the front panel or **TAPE/MD** on the remote control transmitter.

### 5 STEREO indicator

This lights up when an FM stereo broadcast with sufficient signal strength is being received.

### 6 Signal-level meter

This indicates the signal level of the station being received. If multipath interference is detected, the indication decreases.

### 7 RDS mode indicators

The name(s) of RDS mode(s) employed by the currently received RDS station light(s) up. Illumination of one of the named indicators shows that the corresponding RDS mode is now selected.

### 8 DIGITAL, DSP and PRO LOGIC indicators

“**DIGITAL**” lights up when the built-in Dolby Digital decoder is on and the signal of the selected source encoded in Dolby Digital sound is not in 2-channel. “**DSP**” lights up when the built-in digital sound field processor is on, and “**PRO LOGIC**” lights up when the built-in Dolby Pro Logic Surround decoder is on. Depending on the selected DSP program, both “**DIGITAL**” and “**DSP**”, or both “**DSP**” and “**PRO LOGIC**” will light up.

### 9 PTY HOLD indicator

This lights up while a search is being performed in the PTY SEEK mode.

### 10 EON indicator

This lights up when an RDS station that employs the EON data service is being received.

### 11 Program type name indicators

The name selected in the EON mode lights up.

### 12 SLEEP indicator

This lights up while the built-in SLEEP timer is functioning.

# REMOTE CONTROL TRANSMITTER

See "REMOTE CONTROL TRANSMITTER" on page 49 for full details.

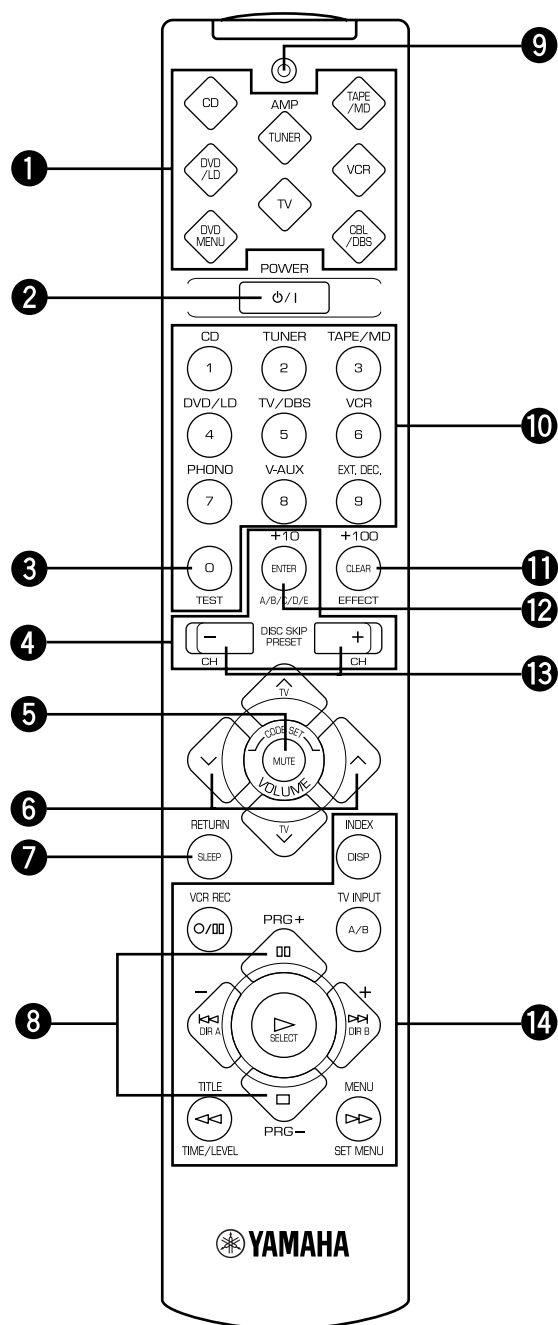

## 1 Component selector

Press the button for the component you want to control with the remote control transmitter. (The proper code must be set for your component. See "SETUP CODES" on page 56.)

When the component selector has been pressed, the remote control transmitter is set to operate that component.

## 2 POWER

When you have preset the code for a YAMAHA component, this button switches between the power on and standby mode.

When you have preset the code for another manufacturer's component, this button turns on that component if it has a remote control transmitter with a power button.

\* It only functions when **AMP<TUNER>**, **TAPE/MD**, **CD**, **DVD/LD** or **DVD MENU** on the component selector has been pressed.

## 3 TEST

Press this button to output the test tone for each speaker.

\* It only functions when **AMP<TUNER>** on the component selector has been pressed.

## 4 A/B/C/D/E, PRESET +/-

These buttons are used to select a preset station.

\* They only function when **AMP<TUNER>** on the component selector has been pressed.

## 5 MUTE

Press this button to mute the sound.

## 6 VOLUME

These buttons are used to adjust the volume.

∧: Turns up the volume.

∨: Turns down the volume.

## 7 SLEEP

This button is used to set the SLEEP timer.

## 8 PRG+, PRG-

These buttons are used to select a DSP program.

\* They only function when **AMP<TUNER>** on the component selector has been pressed.

## 9 Indicator

This flashes in red when a button on the remote control transmitter is pressed. When it flashes rapidly several times, press the selected button again.

## 10 Input selector (1 to 9)<sup>1)</sup>/Numeric buttons<sup>2)</sup>

1) These buttons are used to select the program source to be played.

\* They only function when **AMP<TUNER>**, **TAPE/MD**, **CD** or **DVD/LD** on the component selector has been pressed.

2) These buttons are used to select the menu or channel.

\* They only function when **DVD MENU**, **VCR**, **CBL/DBS** or **TV** on the component selector has been pressed.

**11 EFFECT<sup>1)</sup>/CLEAR<sup>2)</sup>/+100<sup>3)</sup>**

- 1) This button is used to switch the DSP program on or off.
  - \* It only functions when **AMP<TUNER>**, **TAPE/MD**, **CD**, **DVD/LD**, **VCR** or **TV** on the component selector has been pressed.
- 2) This button is used to clear the settings.
  - \* It only functions when **DVD MENU** on the component selector has been pressed.
- 3) This button is used to select the channel.
  - \* It only functions when **CBL/DBS** on the component selector has been pressed.

**12 ENTER<sup>1)</sup>/+10<sup>2)</sup>**

- 1) This button is used to enter the channel.
  - \* It only functions when **VCR**, **CBL/DBS** or **TV** on the component selector has been pressed.
- 2) This button is used to select the menu.
  - \* It only functions when **DVD MENU** on the component selector has been pressed.

**13 DISC SKIP +/-<sup>1)</sup>/CH +/-<sup>2)</sup>**

- 1) These buttons are used to skip to the next or previous disc.
  - \* They only function when **CD**, **DVD/LD** or **DVD MENU** on the component selector has been pressed.
- 2) These buttons are used to select the next or previous channel.
  - \* They only function when **VCR**, **CBL/DBS** or **TV** on the component selector has been pressed.

**14 Operation buttons<sup>1)</sup>/Setup buttons<sup>2)</sup>**

- 1) These buttons function as play, stop, skip, etc. for operating the component.
  - \* They only function when **TAPE/MD**, **CD**, **DVD/LD**, **VCR** or **TV** on the component selector has been pressed.
- 2) These buttons are for adjusting various settings.
  - \* They only function when **AMP<TUNER>**, **DVD MENU** or **CBL/DBS** on the component selector has been pressed.

# SPEAKER SETUP

## SPEAKERS TO BE USED

This unit is designed to provide the best sound-field quality with a 5-speaker configuration, using main speakers, rear speakers and a center speaker.

The main speakers are used for the main source sound plus the effect sounds. They will probably be the speakers from your present stereo system. The rear speakers are used for the effect and surround sounds, and the center speaker is for the center sounds (dialog, vocals, etc.). If for some reason it is not practical to use a center speaker, you can do without it. Best results, however, are obtained with the full system.

The main speakers should be high-performance models and have enough power-handling capacity to accept the maximum output of your audio system.

The other speakers do not have to be equal to the main speakers. For precise sound localization, however, it is ideal to use high-performance models that can reproduce sounds over the full-range for the center speaker and the rear speakers.

### Use of a subwoofer expands your sound field

It is also possible to further expand your system with the addition of a subwoofer and amplifier. The use of a subwoofer is effective not only for reinforcing bass frequencies from any or all channels, but also for reproducing the LFE (low frequency effect) sound with high fidelity when playing back a source that is Dolby Digital-decoded. You may wish to choose the convenience of a YAMAHA Active Servo Processing Subwoofer System, which has its own built-in power amplifier.

## SPEAKER CONFIGURATION

### 5-Speaker Configuration

This configuration is the most effective and recommended one. When playing back a source using the DSP program, **DOLBY PRO LOGIC/DOLBY DIGITAL, DOLBY PRO LOGIC ENHANCED/DOLBY DIGITAL ENHANCED, 70 mm MOVIE THEATER/DIGITAL MOVIE THEATER, MONO MOVIE** or **TV SPORTS**, or when playing back a source which contains center-channel signals (dialog, vocals, etc.) using any DSP program that is Dolby Digital-decoded, conversations will be output from the center speaker and the ambience will be excellent.

**Note:** Set the CNTR (CENTER SPEAKER) mode to the "LARGE" or "SMALL" position. (See page 21 for details.)

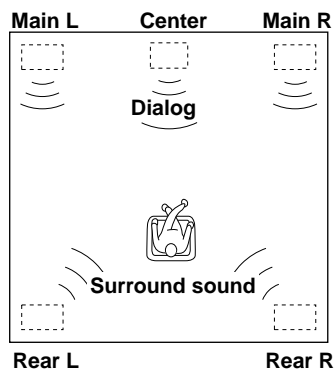

### 4-Speaker Configuration

The center speaker is not used in this configuration. When playing back a source using the DSP program, **DOLBY PRO LOGIC/DOLBY DIGITAL, DOLBY PRO LOGIC ENHANCED/DOLBY DIGITAL ENHANCED, 70 mm MOVIE THEATER/DIGITAL MOVIE THEATER, MONO MOVIE** or **TV SPORTS**, or when playing back a source which contains center-channel signals (dialog, vocals, etc.) using any DSP program that is Dolby Digital-decoded, the center sound is output from the left and the right main speakers. However, the sound effect of other programs will be the same as that of the 5-speaker configuration.

**Note:** Be sure to set the CNTR (CENTER SPEAKER) mode to the "NONE" position. (See page 21 for details.)

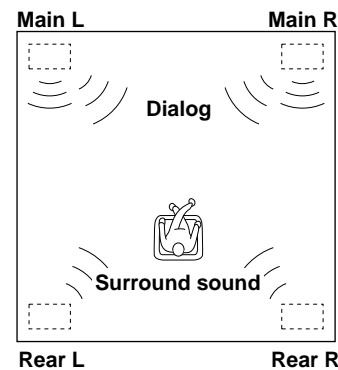

## SPEAKER PLACEMENT

Refer to the following diagram when you place the speakers.

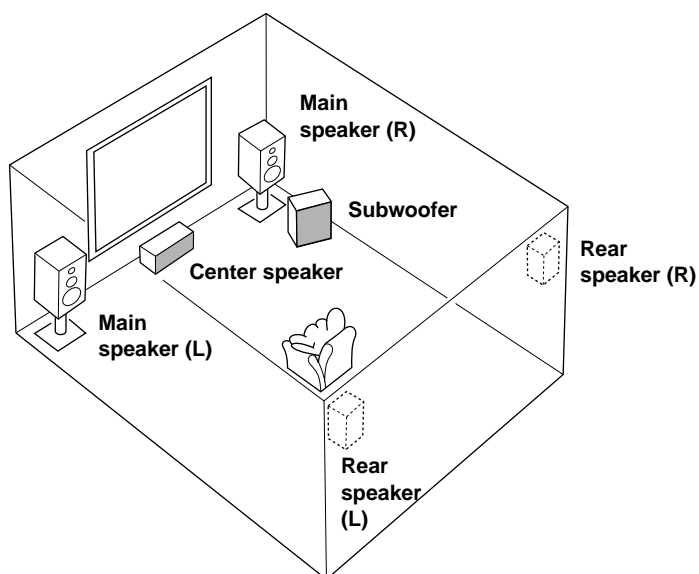

**Main:** The position of your present stereo speaker system.

**Rear:** Behind your listening position, facing slightly inward. Nearly 1.8 m (approx. 6 feet) up from the floor.

**Center:** Precisely between the main speakers. (To avoid interference with TV sets, use a magnetically shielded speaker.)

**Subwoofer:** The position of the subwoofer is not as critical, because low bass tones are not highly directional.

# CONNECTIONS

Never plug in this unit and other components until all connections have been completed.

## CONNECTIONS WITH OTHER COMPONENTS

When making connections between this unit and other components, be sure all connections are made correctly, that is to say **L** (left) to **L**, **R** (right) to **R**, “+” to “+” and “-” to “-”. Also, refer to the owner’s manual for each component to be connected to this unit.

\* If you have YAMAHA components numbered as **1**, **3**, **4**, etc. on the rear panel, connections can be made easily by making sure to connect the output (or input) terminals of each component to the same-numbered terminals of this unit.

### \*<sup>1</sup> SWITCHED AC OUTLET(S)

Europe model ..... 2 SWITCHED OUTLETS

U.K. model ..... 1 SWITCHED OUTLET

Use these to connect the power cords from your components to this unit.

The power to the **SWITCHED AC OUTLET(S)** is controlled by this unit’s **STANDBY/ON** or the provided remote control transmitter’s **POWER**. These outlets will supply power to any component whenever this unit is turned on.

The maximum power (total power consumption of components) that can be connected to the **SWITCHED AC OUTLET(S)** is 100 watts.

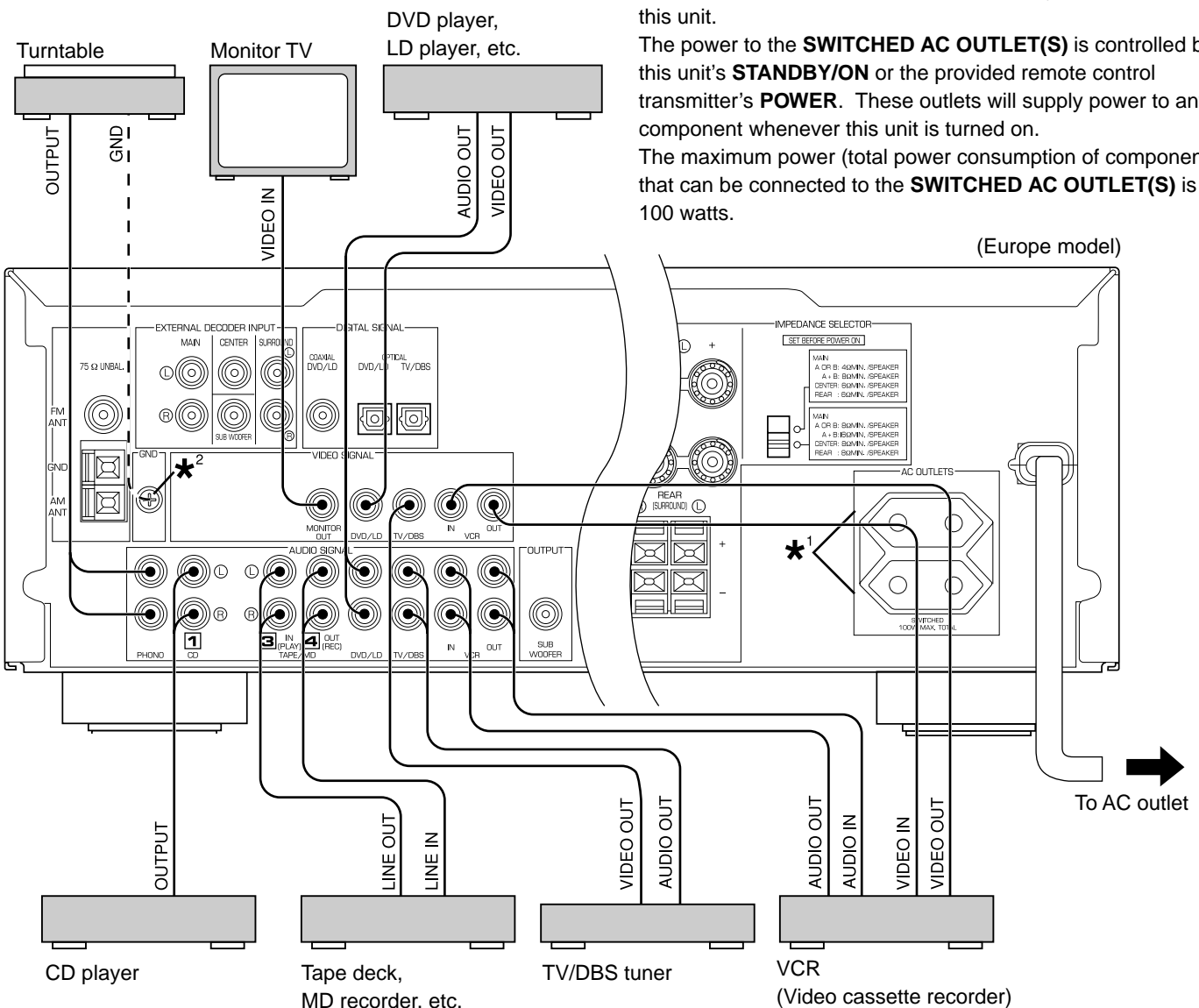

### \*<sup>2</sup> GND terminal (for turntable use)

Connecting the ground (earth) wire of the turntable to the **GND** terminal will normally minimize hum, but in some cases, better results may be obtained with the ground wire disconnected.

## CONNECTING TO VIDEO AUX TERMINALS (ON THE FRONT PANEL)

These terminals are used to connect any video input source, such as a camcorder, to this unit.

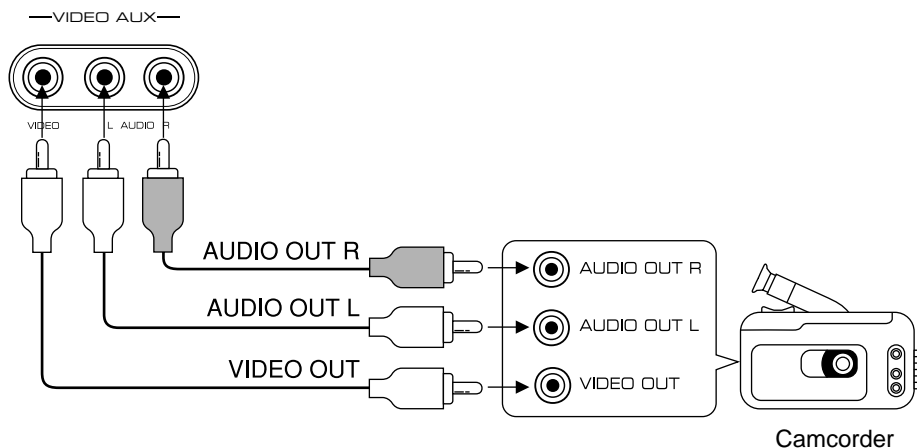

## CONNECTING TO AN EXTERNAL DECODER

When using the DTS or other decoder with 6-channel discrete outputs, connect the **6CH DISCRETE OUTPUT** terminals of the decoder to the **EXTERNAL DECODER INPUT** terminals of this unit.

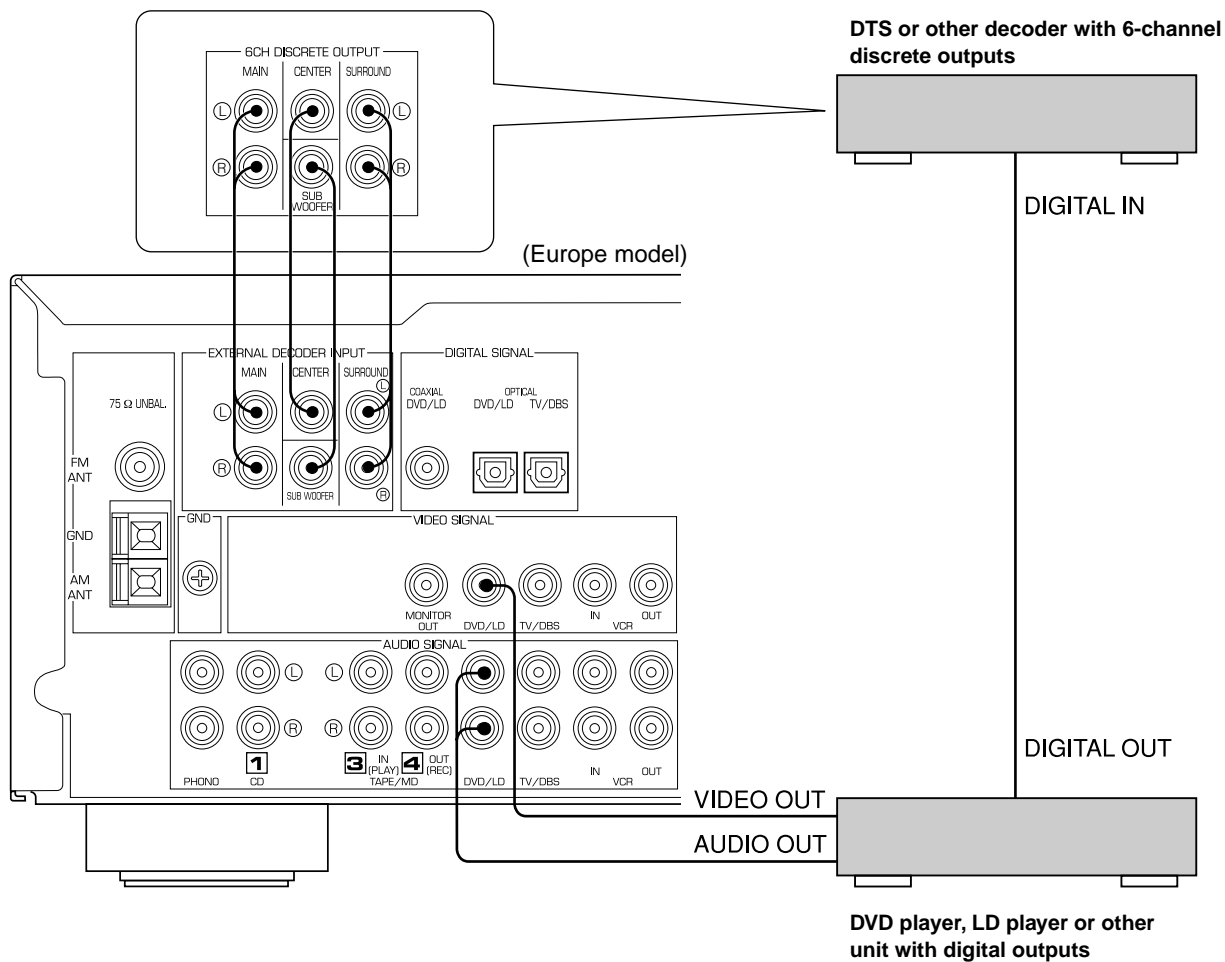

## CONNECTING TO DIGITAL (COAXIAL AND/OR OPTICAL) TERMINALS

If your DVD (LD) player, TV/DBS tuner, etc. are equipped with coaxial or optical digital audio signal output terminals, they can be connected to this unit's **COAXIAL** and/or **OPTICAL** digital signal input terminals.

To make a connection between optical digital audio signal terminals, remove the cover from each terminal, and then connect them by using a commercially available optical fiber cable that conforms to EIAJ standards. Other cables might not function correctly.

Even if you connect an audio/video unit to the **COAXIAL** (or **OPTICAL**) terminal of this unit, you must keep the unit connected with the same named analog audio signal terminals of this unit, because a digital signal cannot be recorded by a tape deck, MD recorder or VCR connected to this unit. You can easily switch the selection of input signals between "digital" and "analog". (See page 28 for details.)

### Notes

- When connecting an audio/video unit to both the digital and analog terminals of this unit, make sure to connect between terminals of the same name.
- Be sure to attach the covers when the **OPTICAL** terminals are not being used in order to protect them from dust.
- The input signal from the DVD/LD input terminals is selected in the following order of priority with the input mode set to the AUTO position:
  - 1 **COAXIAL** terminal
  - 2 **OPTICAL** terminal
  - 3 Analog terminal
- All digital audio signal input terminals are applicable to sampling frequencies of 32 kHz, 44.1 kHz and 48 kHz.
- If your LD player has Dolby Digital RF signal output terminal, use the RF demodulator (separate purchase).

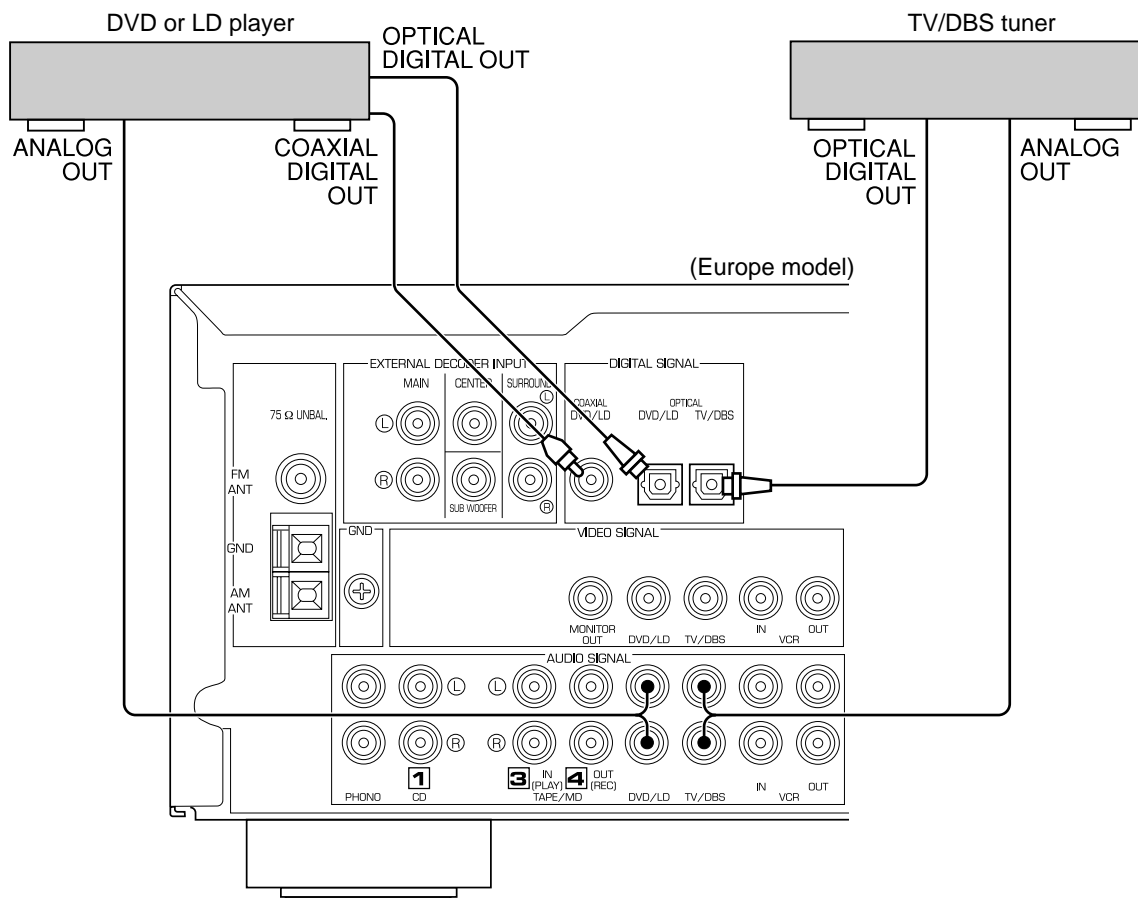



## CONNECTING SPEAKERS

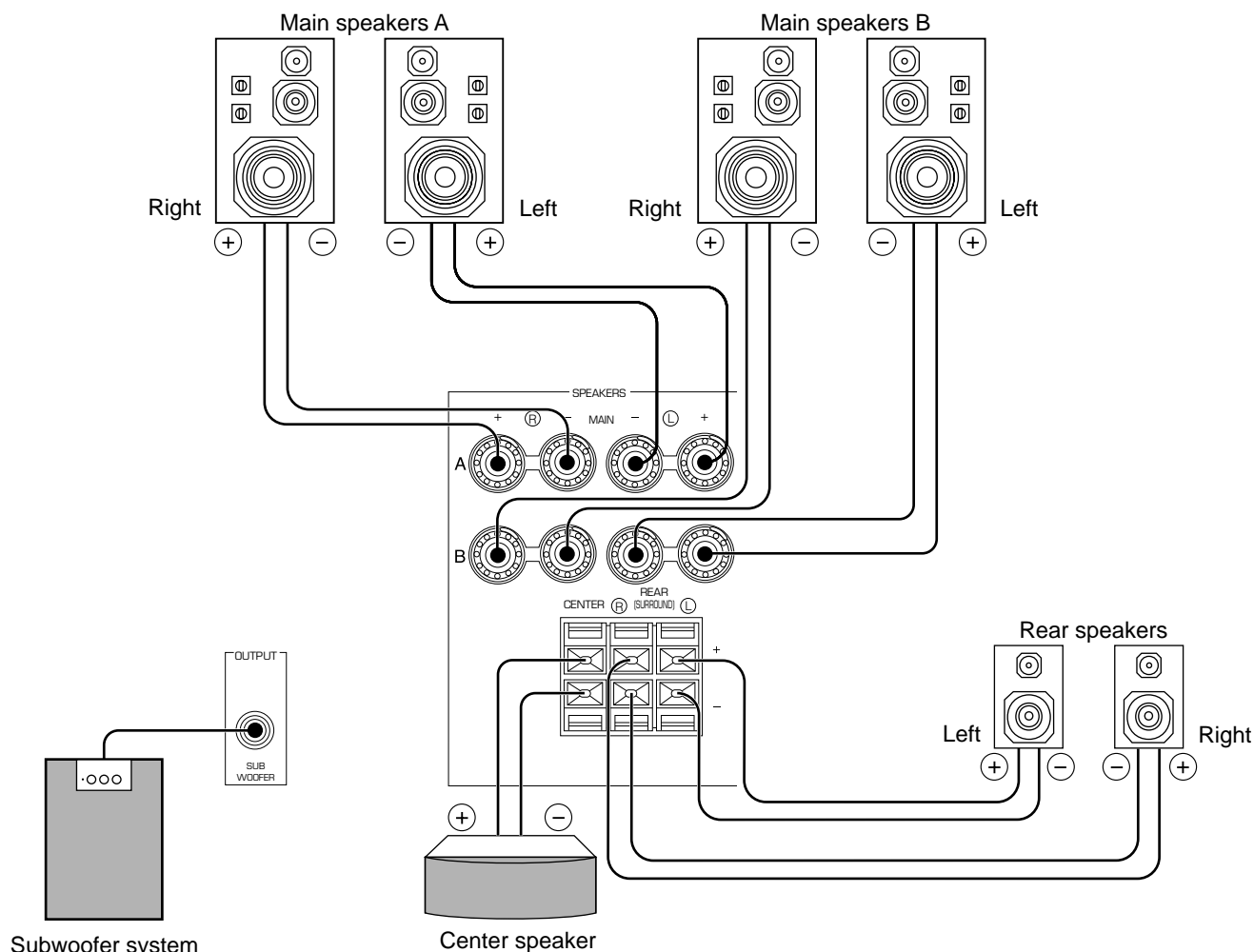

### Note

Use speakers with the specified impedance shown on the rear panel of this unit.

### Main speaker connections

One or two speaker systems can be connected to this unit. If you use only one speaker system, connect it to either of the **SPEAKERS A** or **B** terminals.

### Rear speaker connections

A rear speaker system can be connected to this unit. Place them to the rear of your listening position.

### Center speaker connection

A center speaker can be connected to this unit. Place it on or under the TV.

### Subwoofer connection

You may wish to add a subwoofer to reinforce low frequencies or to output low bass sound from the subwoofer channel.

If you have a subwoofer with built-in amplifier, including the YAMAHA Active Servo Processing Subwoofer System, connect the **SUBWOOFER OUTPUT** terminal of this unit to the input terminal of the subwoofer system.

If you have a separate amplifier and subwoofer, connect the **SUBWOOFER OUTPUT** terminal of this unit to the input terminal of the subwoofer amplifier, and then connect the speaker terminals of the subwoofer amplifier to the subwoofer. When the input signals to this unit are for normal 2-channel stereo, this terminal outputs only frequencies below 90 Hz from the main and center channels. When discrete signals are input to this unit and are selected as the input source, this terminal outputs signals from the subwoofer channel.

**Note:** The output level of signals from this terminal is adjusted by **VOLUME** on the front panel or **VOLUME** ( ^ v ) on the remote control transmitter.

## How to connect

Connect the **SPEAKERS** terminals to your speakers with wire of the proper gauge, cut as short as possible. If the connections are faulty, no sound will be heard from the speakers. Make sure that the polarity of the speaker wires is correct, that is the + and – markings are observed. If these wires are reversed, the sound will be unnatural and lack bass.

### Caution

**Do not let the bare speaker wires touch each other and do not let them touch any metal part of this unit. This could damage the unit and/or speakers.**

### Connecting to the MAIN SPEAKERS terminals

Red: positive (+)  
Black: negative (-)

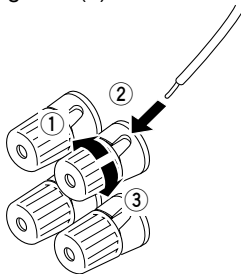

- ① Unscrew the knob.
- ② Remove approx. 5 mm (1/4") of insulation from each of the speaker wires and insert the bare wire into the terminal.
- ③ Tighten the knob to secure the wire.

### Connecting to the REAR and CENTER SPEAKERS terminals

Red: positive (+)  
Black: negative (-)

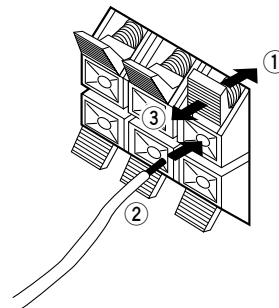

- ① Press the tab.
- ② Remove approx. 5 mm (1/4") of insulation from each of the speaker wires and insert the bare wire into the terminal.
- ③ Release the tab to secure the wire.

# IMPEDANCE SELECTOR SWITCH

### WARNING

Do not change the **IMPEDANCE SELECTOR** switch setting while the power to this unit is on, otherwise this unit may be damaged.

If this unit fails to turn on when the **STANDBY/ON** switch is pressed, the **IMPEDANCE SELECTOR** switch may not be fully set to either end. If so, set the switch to either end fully when this unit is in the standby mode.

Select the position whose requirements your speaker system meets.

 (Upper position)

**Main:** If you use one pair of main speakers, the impedance of each speaker must be 4 Ω or higher.  
If you use two pairs of main speakers, the impedance of each speaker must be 8 Ω or higher.

**Center:** The impedance of the speaker must be 6 Ω or higher.

**Rear:** The impedance of each speaker must be 6 Ω or higher.

 (Lower position)

**Main:** If you use one pair of main speakers, the impedance of each speaker must be 8 Ω or higher.  
If you use two pairs of main speakers, the impedance of each speaker must be 16 Ω or higher.

**Center:** The impedance of the speaker must be 8 Ω or higher.

**Rear:** The impedance of each speaker must be 8 Ω or higher.

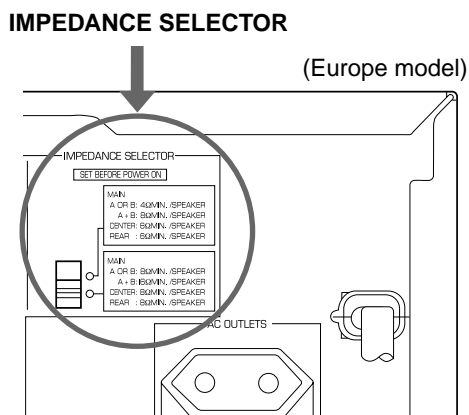

# ANTENNA CONNECTIONS

Each antenna should be correctly connected to the designated terminals, referring to the following diagram. Both AM and FM indoor antennas are included with this unit. In general, these antennas will probably provide sufficient signal strength. Nevertheless, a properly installed outdoor antenna will give clearer reception than an indoor one. If you experience poor reception quality, an outdoor antenna may result in improvement.

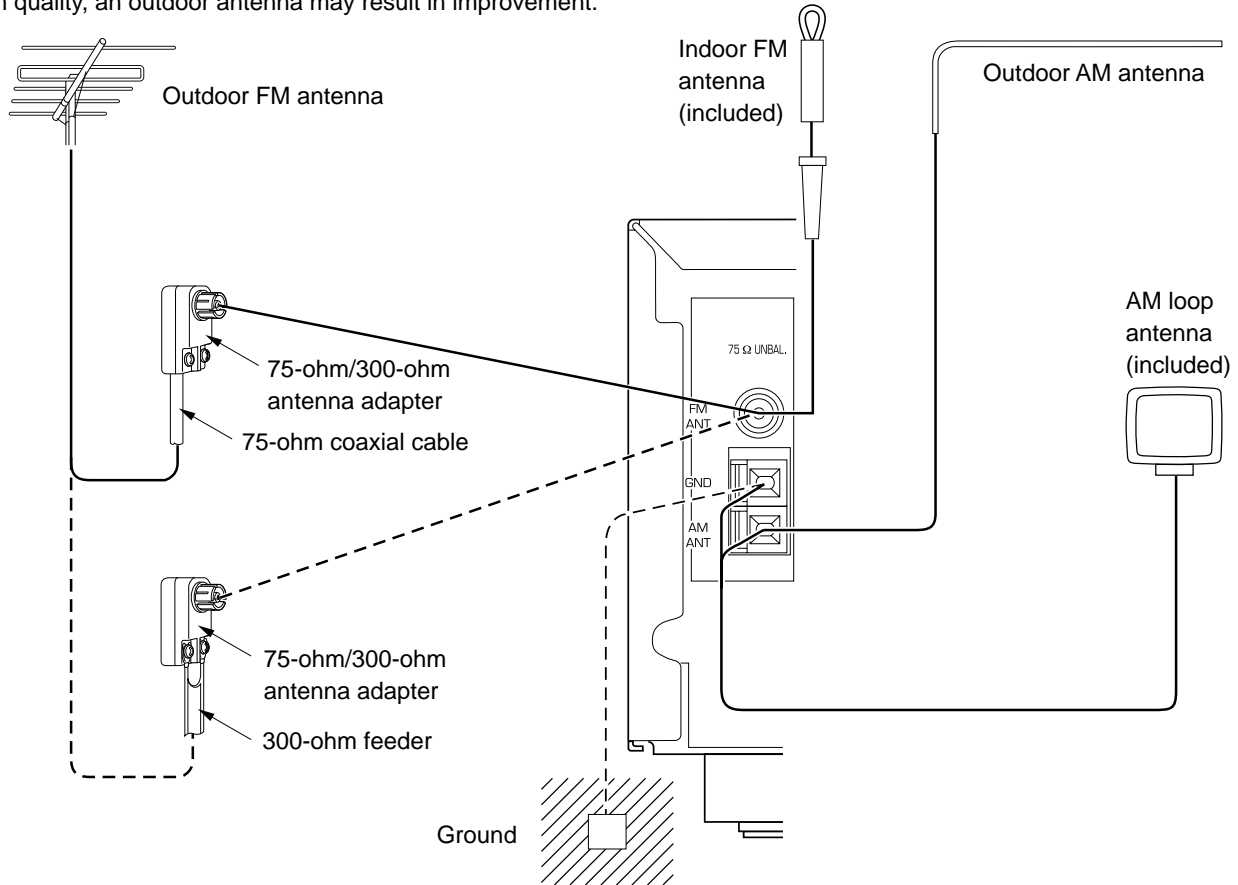

## Connecting the AM loop antenna

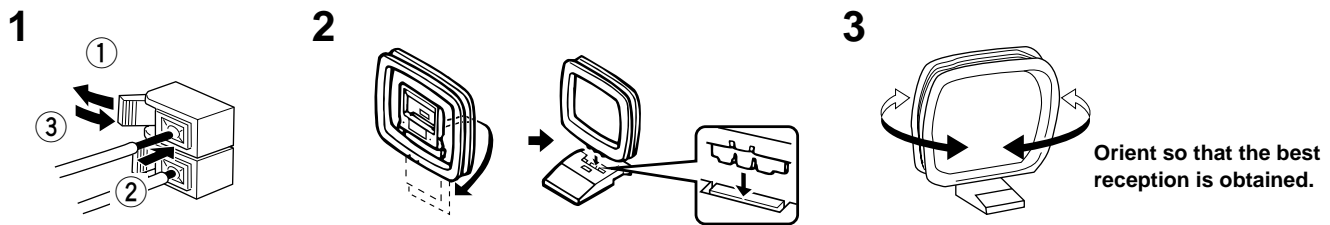

- \* The AM loop antenna should be placed away from this unit. The antenna may be hung on a wall.
- \* The AM loop antenna always should be connected, even if an outdoor AM antenna is connected to this unit.

## GND TERMINAL

For maximum safety and minimum interference, connect the **GND** terminal to a good earth ground. A good earth ground is a metal stake driven into moist earth.

## Notes

- When connecting the indoor FM antenna, firmly insert its connector into the **FM ANT** terminal.
- If you need an outdoor FM antenna to improve FM reception quality, either 300-ohm feeder or coaxial cable may be used. In locations troubled by electrical interference, coaxial cable is preferable.

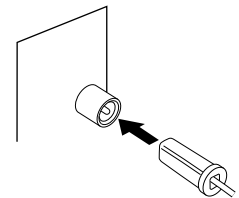

# ADJUSTMENTS BEFORE USING THIS UNIT

## SELECTING THE OUTPUT MODES

This unit provides you the following five functions to determine the method of distributing output signals to speakers suitable for your audio system. When speaker connections have all been completed, select the proper setting for each function to make the best use of your speaker system. (See "ADJUSTMENTS IN THE 'SET MENU' MODE" on page 47.)

- |                                 |                                |                                |
|---------------------------------|--------------------------------|--------------------------------|
| <b>1. CNTR (CENTER SPEAKER)</b> | <b>2. REAR (REAR SPEAKERS)</b> | <b>3. MAIN (MAIN SPEAKERS)</b> |
| <b>4. BASS (LFE/BASS OUT)</b>   | <b>5. M.LVL (MAIN LEVEL)</b>   |                                |

### DESCRIPTION OF EACH FUNCTION

#### CNTR (CENTER SPEAKER)

**Choices:** LARGE/SMALL/NONE

**Preset position:** LARGE

**LARGE:** Select this position when your center speaker is approximately the same size as the main speakers.

**SMALL:** Select this position when you use a center speaker that is smaller than the main speakers.  
In this position, low bass signals (below 90 Hz) on the center channel are output from the main speakers (or the **SUBWOOFER OUTPUT** terminal if the SMALL position is selected for "MAIN" and the SW position is selected for "BASS").

**NONE:** Select this position when you do not have a center speaker. The center channel sound will be output from the left and right main speakers.

#### REAR (REAR SPEAKERS)

**Choices:** LARGE/SMALL

**Preset position:** LARGE

**LARGE:** Select this position if your rear speakers have high ability for bass reproduction, or a subwoofer is connected to the rear speaker in parallel.  
In this position, full-range signals are output from the rear speakers.

**SMALL:** Select this position if your rear speakers do not have high ability for bass reproduction.  
In this position, low bass signals (below 90 Hz) on the rear channels are output from the **SUBWOOFER OUTPUT** terminal (or the main speakers if the MAIN position is selected for "BASS").

#### MAIN (MAIN SPEAKERS)

**Choices:** LARGE/SMALL

**Preset position:** LARGE

**LARGE:** Select this position if your main speakers have high ability for bass reproduction.  
In this position, full-range signals present on the main channels are output from the main speakers.

**SMALL:** Select this position if your main speakers do not have high ability for bass reproduction. However, if your system does not include a subwoofer, do not select this position.  
In this position, low bass signals (below 90 Hz) on the main channels are output from the **SUBWOOFER OUTPUT** terminal if the SW or BOTH position is selected for "BASS".

#### BASS (LFE/BASS OUT)

**Choices:** SW/MAIN/BOTH

**Preset position:** SW

**MAIN:** Select this position if your system does not include a subwoofer.  
In this position, full-range signals present on the main channels, signals from the LFE channel and other low bass signals that are selected for "CNTR" to "MAIN" to be distributed from other channels are output from the main speakers.

**SW/BOTH:**  
Select either the SW or BOTH position if your system includes a subwoofer.  
In either position, signals on the LFE channel and other low bass signals that are selected for "CNTR" to "MAIN" to be distributed from other channels are output from the **SUBWOOFER OUTPUT** terminal. When the LARGE position is selected for "MAIN", in the SW position, no signal is distributed from the main channels to the **SUBWOOFER OUTPUT** terminal; however, in the BOTH position, low bass signals from the main channels are output to both the main speakers and the **SUBWOOFER OUTPUT** terminal.

#### M.LVL (MAIN LEVEL)

**Choices:** NRML (NORMAL)/-10 dB

**Preset position:** NRML (NORMAL)

**NRML (NORMAL):**

Normally select this position.

**-10 dB:** Select this position if the sound output from the main speakers is too loud and cannot be balanced with the sound output from the center and rear speakers. In this position, the sound output from the main speakers is attenuated.

# ADJUSTING METHOD

Adjustments should be made while watching the information on this unit's display.

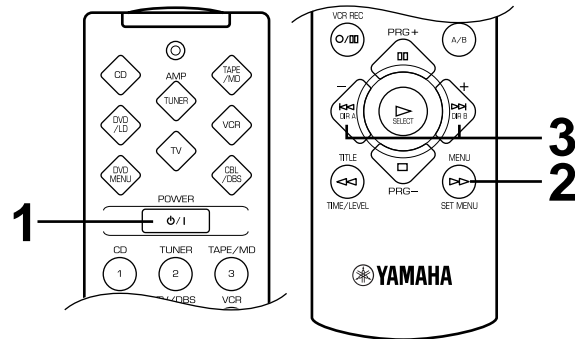
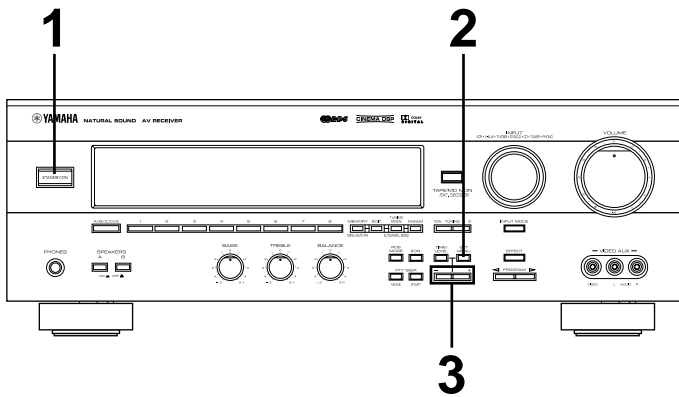

When adjusting with the remote control transmitter, press **AMP<TUNER>** on the component selector on the remote control transmitter.



**3** Press **+** or **-** once or more to select the setting you want.

Front panel

Remote control

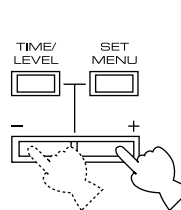

or

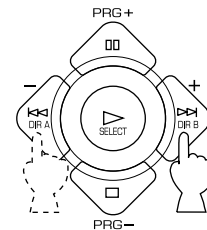

CNTR>SMALL

**1** Turn the power on.

Front panel

Remote control

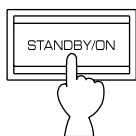

or

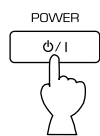

**2** Press **SET MENU** once or more to select the function "CNTR" on the display.

Front panel

Remote control

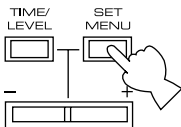

or

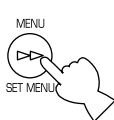

CNTR>LARGE

**4** Repeat steps 2 and 3 to change the setting for "REAR", "MAIN", "BASS" and/or "M.LVL" in the same way.

## SPEAKER BALANCE ADJUSTMENT

This procedure lets you adjust the sound output level balance between the main, center and rear speakers by using the built-in test tone generator. When this adjustment is performed, the sound output level heard at the listening position will be the same from each speaker. This is important for the best performance of the digital sound field processor, the Dolby Digital decoder and the Dolby Pro Logic Surround decoder.

**The adjustment of each speaker output level should be done at your listening position with the remote control transmitter. After completing the adjustment of the output level for each speaker, use VOLUME ( ^ v ) on the remote control transmitter at your listening position to check if the adjustments are satisfactory.**

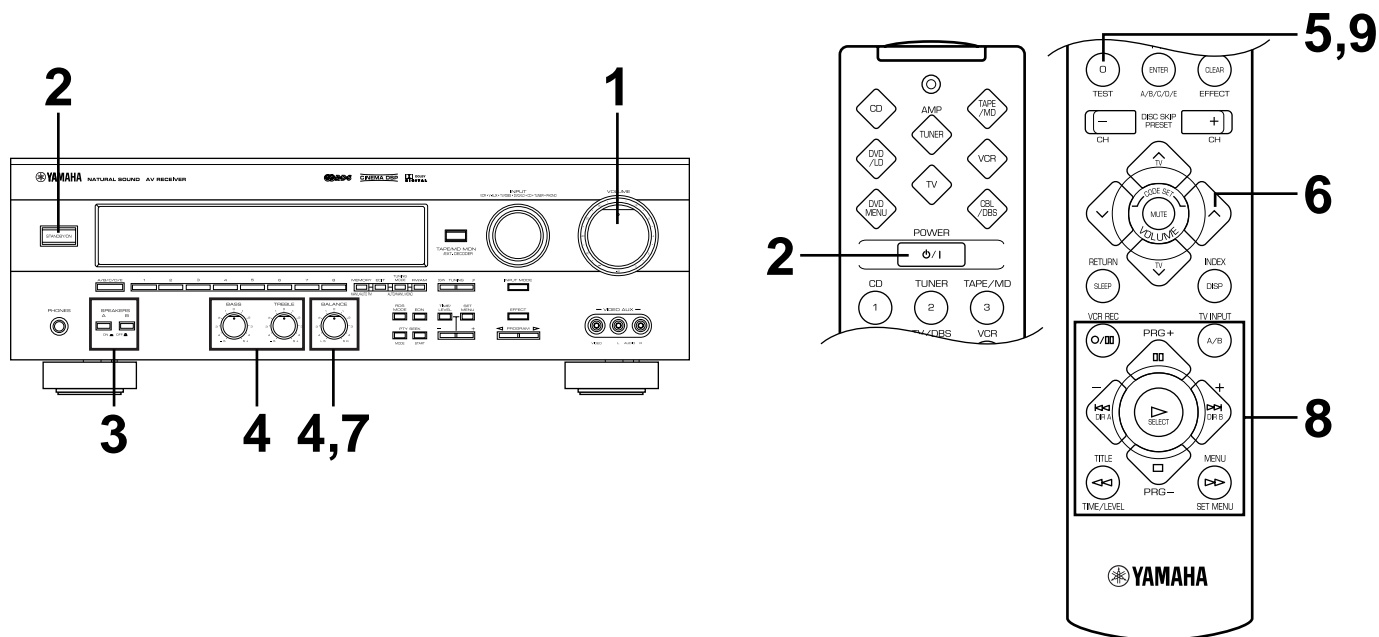

Press **AMP<TUNER>** on the component selector on the remote control transmitter.



**1** Set **VOLUME** to the “∞” position.

**Front panel**

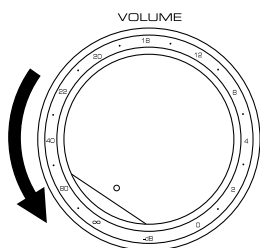

**2** Turn the power on.

**Front panel**

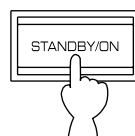

**Remote control**

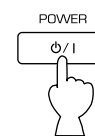

or

**3** Select the main speakers to be used.

**Front panel**

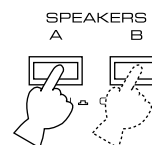

\* If you use two main speaker systems, press both **A** and **B**.

**4** Set **BASS**, **TREBLE** and **BALANCE** to the “0” position.

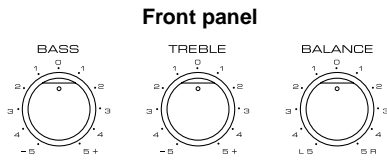

**5** Press **TEST** so that “TEST LEFT” appears on the display.

**Remote control**

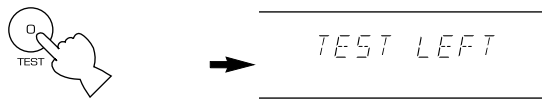

**6** Turn up the volume.

**Remote control**

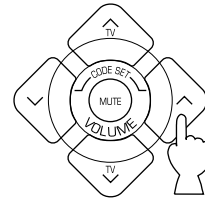

You will hear a test tone (like pink noise) from each speaker for about two seconds in following order: left main speaker, center speaker, right main speaker, right rear speaker and left rear speaker. The display changes as shown below.

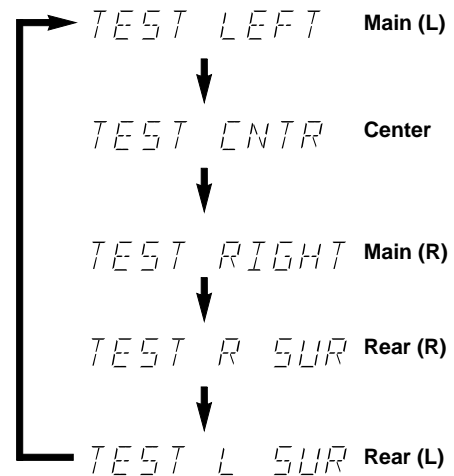

\* If the function “CNTR” in the SET MENU mode is set to the NONE position, you will hear the center channel test tone from the left and right main speakers.

**7** Adjust **BALANCE** so that the sound output level of the left main speaker and the right main speaker is the same.

**Front panel**





**8** Adjust the sound output levels of the center speaker and the rear speakers so that they become almost the same as that of the main speakers.

Press **TIME/LEVEL** once or more to select the speaker to be adjusted so that "CENTER", "R SUR.", "L SUR." or "SWFR" appears on the display.

**Remote control**



\* You cannot adjust the delay time while the test tone is sounding even if "DELAY" appears on the display after pressing **TIME/LEVEL** once or more.

Adjust the level.

- \* Pressing **+** raises and **-** lowers the level.
- \* While adjusting, the test tone is fixed on the selected speaker.

**Remote control**

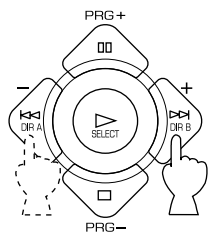

**Notes**

- Once you have completed these adjustments, you can only adjust the overall sound level of your audio system by using **VOLUME** (or **VOLUME** ( ^ v ) on the remote control transmitter).
- If you use external power amplifiers, you may also use their volume controls to achieve the proper balance.
- If the function "CNTR" in the SET MENU mode is set to the NONE position, the sound output level of the center speaker cannot be adjusted in step 8. The center sound is automatically output from the left and right main speakers.
- If there is insufficient sound output from the center and rear speakers, you may decrease the main speaker output level by setting "M.LVL" to "-10 dB".

**9** Press **TEST** again to stop the test tone.

**Remote control**

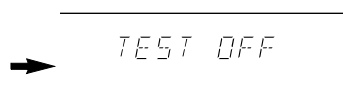
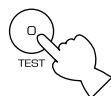

# BASIC OPERATIONS

## TO PLAY A SOURCE

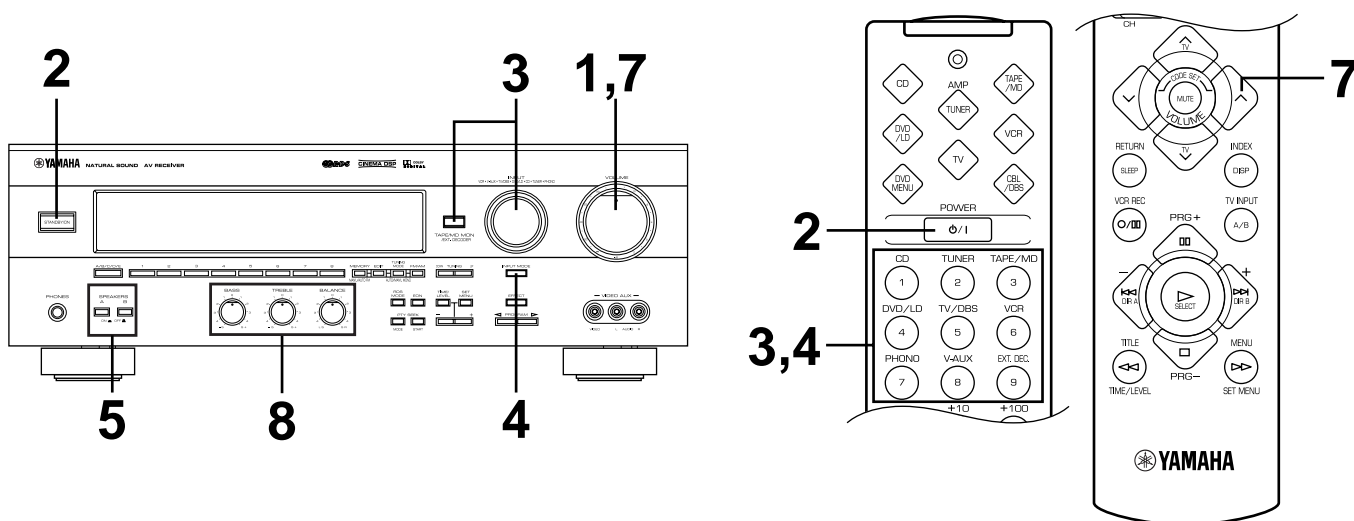

### When using the remote control transmitter

- Press **AMP<TUNER>** on the component selector.
- When controlling an audio/visual component (tape deck, MD recorder, CD player, DVD/LD player, etc.), press the button on the component selector, **TAPE/MD**, **CD**, **DVD/LD**, etc., for the component you want to control. (See "SETUP CODES" on page 56.)

- 1 Set **VOLUME** to the "∞" position.

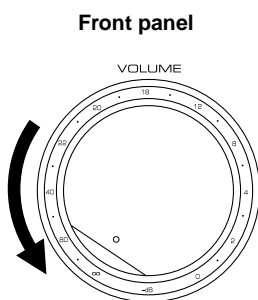

- 2 Turn the power on.

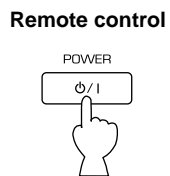
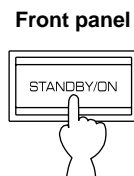

- 3 Select the desired program source by using **INPUT**. (Turn on the TV/monitor for video sources.)

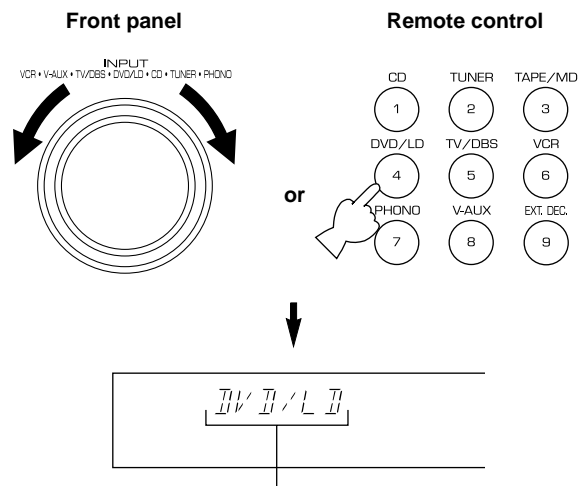

The name of the selected program source will appear on the display.

### To play a tape or an MD

Press **TAPE/MD MON / EXT. DECODER** on the front panel or **TAPE/MD** on the remote control transmitter so that the "TAPE/MD MON" indicator lights up on the display.

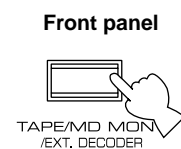

### To use a decoder connected to the EXTERNAL DECODER INPUT terminals

Press **TAPE/MD MON / EXT. DECODER** once or more on the front panel or **EXT. DEC.** on the remote control transmitter so that "EXT. DECDR" appears on the display.

- 4** For a DVD/LD or TV/DBS source, the current input mode is also shown.
- \* To change the input mode for the DVD/LD or TV/DBS source, press **INPUT MODE** (or the button that you have pressed to select the program source in step 3 on the remote control transmitter) once or more until the desired input mode (AUTO or ANALOG) is shown on the display. (See page 28 for details on switching the input mode.)

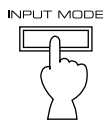
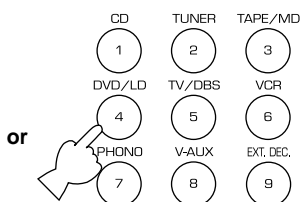
**Front panel****Remote control**

or

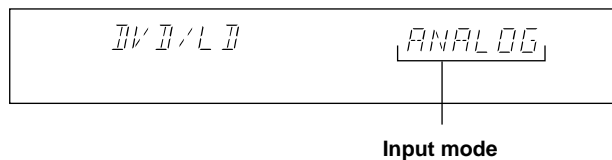

Input mode

- 5** Select the main speakers to be used.

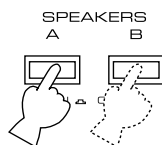
**Front panel**

\* If you use two main speaker systems, press both **A** and **B**.

- 6** Play the source. (See page 30 for detailed information on tuning.)

- 7** Adjust the volume to the desired output level.

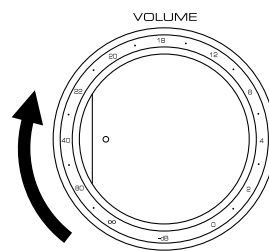
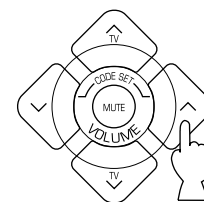
**Front panel****Remote control**

or

- 8** If desired, adjust **BASS**, **TREBLE**, **BALANCE**, etc. and use the digital sound field processor (see page 41).

**BASS:** Turn this control clockwise to increase (or counterclockwise to decrease) the low-frequency response.

**TREBLE:** Turn this control clockwise to increase (or counterclockwise to decrease) the high-frequency response.

**BALANCE:** Adjust the balance of the output volume from the left and right speakers to compensate for sound imbalance caused by the speaker location or listening room conditions.

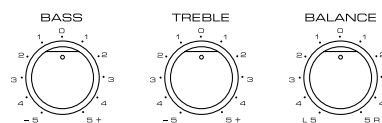
**Front panel**

\* These controls are only effective for the sound from the main speakers.

**When you have finished using this unit**

Press **STANDBY/ON** on the front panel again or **POWER** on the remote control transmitter to set this unit to the standby mode.

## Notes on using INPUT

- The audio source selected by **INPUT** will not be played if the "TAPE/MD MON" indicator lights up or if "EXT. DECDR" is displayed.
- If you select **INPUT** for a video source without canceling the selection of **TAPE/MD MON / EXT. DECODER** on the front panel (or **TAPE/MD** or **EXT. DEC.** on the remote control transmitter), the play back result will be a video image from the video source and the sound from the audio source selected by **TAPE/MD MON / EXT. DECODER** on the front panel (or **TAPE/MD** or **EXT. DEC.** on the remote control transmitter).
- Once you start playing a video source, the video image will not be interrupted even if **INPUT** for an audio source is selected.
- When you select a program source by using **INPUT**, the DSP program (or no DSP program) that was being used when the same program source was selected the last time, will be automatically recalled.

## Switching the input mode (for DVD/LD and TV/DBS)

This unit allows you to switch the input mode only for those sources connected to the DVD/LD and TV/DBS input terminals (on the rear panel of this unit) that input two or three types of signal.

The following two input modes are provided:

### **AUTO For a source connected to the DVD/LD input terminals**

This mode is automatically selected when you turn on the power to this unit. In this mode, the input signal is automatically selected in the following order of priority:

1. Digital input signal from the **COAXIAL** terminal
2. Digital input signal from the **OPTICAL** terminal
3. Analog input signal

### **For a source connected to the TV/DBS input terminals**

This mode is selected when you turn on the power to this unit if the AUTO position is selected for "INPUT" in the SET MENU mode. (See page 48 for details.) In this mode, the input signal is automatically selected in the following order of priority:

1. Digital input signal from the **OPTICAL** terminal
2. Analog input signal

### **ANALOG**

In this mode, only an analog input signal is selected, even if a digital signal is input at the same time. Select this mode when you want to use the analog input signal instead of the digital input signal.

### **Notes on input mode selection**

- To play back a source that is Dolby Digital-decoded, set the input mode to AUTO.
- For the TV/DBS source only, the input mode selected for "INPUT" in the SET MENU mode is effective when you turn on the power to this unit.
- When you want to enjoy a source which has normal 2-channel signals with a Dolby Pro Logic Surround program, select the ANALOG mode.
- In the AUTO mode, there may be a case, depending on the LD player or DVD player, that when you search for a source encoded with Dolby Digital during play and then play is restored, the sound output is interrupted for a moment because the digital input signal is selected again.

# TO RECORD A SOURCE ON TAPE OR MD

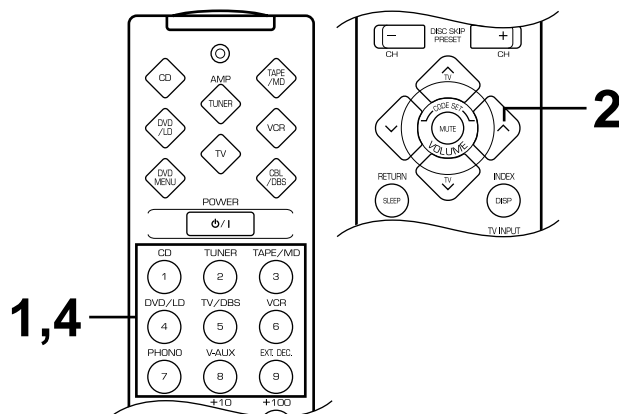
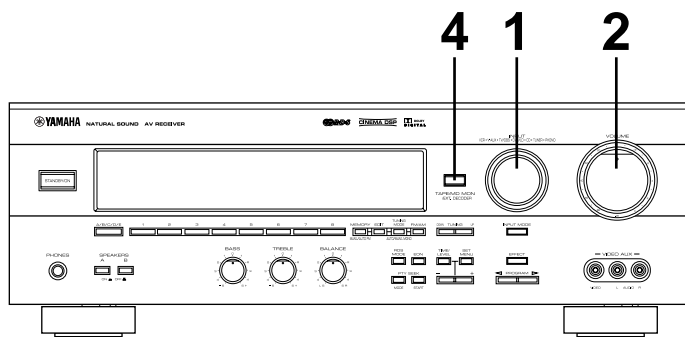

**1** Select the source to be recorded.

**Front panel**  
 INPUT  
 VCR • V-AUX • TV/DBS • DVD/LD • CD • TUNER • PHONO

**Remote control**

CD	TUNER	TAPE/MD
1	2	3
DVD/LD	TV/DBS	VCR
4	5	6
PHONO	V-AUX	EXT. DEC.
7	8	9

or

**2** Play the source and then turn up the volume to confirm the program source. (See page 30 for detailed information on tuning.)

**Front panel**  
 VOLUME

**Remote control**

or

**3** Begin recording on the tape deck, MD recorder or VCR connected to this unit.

**4** When a tape deck or MD recorder is being used for recording, you can monitor the sounds being recorded by pressing **TAPE/MD MON / EXT. DECODER** on the front panel or **TAPE/MD** on the remote control transmitter so that the "TAPE/MD MON" indicator lights up on the display.

**Front panel**  
 TAPE/MD MON / EXT. DECODER

or

**Remote control**  
 TAPE/MD

**Notes**

- The settings of DSP and **VOLUME, BASS, TREBLE** and **BALANCE** have no effect on the material being recorded.
- A source that is connected to this unit only through the digital terminals cannot be recorded by a tape deck, MD recorder or VCR connected to this unit.
- Please check the copyright laws in your country to record from records, compact discs, radio, etc. Recording of copyright material may infringe copyright laws.

If you use a video source that has scrambled or encoded signals to prevent it from being dubbed, there may be a case that the picture itself will be affected by those signals.

# TUNING OPERATIONS

Set **INPUT** on the front panel to the TUNER position. When using the remote control transmitter, press **AMP<TUNER>** on the component selector and then press **TUNER** on the input selector.

Normally, if station signals are strong and there is no interference, quick automatic-search tuning (AUTOMATIC TUNING) is possible. However, if the signal from the station you want to select is weak, you must tune in to it manually (MANUAL TUNING).

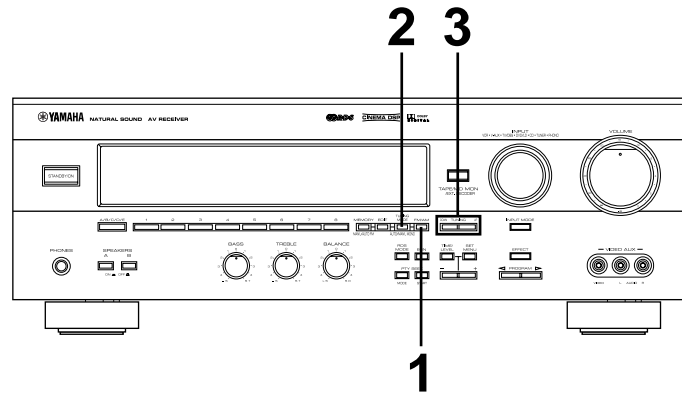

## AUTOMATIC TUNING

- 1 Select the reception band (FM or AM) and confirm it on the display.

Front panel

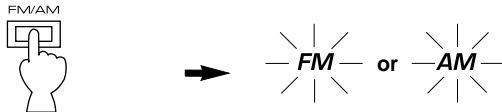

- 2 Press **TUNING MODE** so that the "AUTO TUNING" indicator lights up on the display.

Front panel

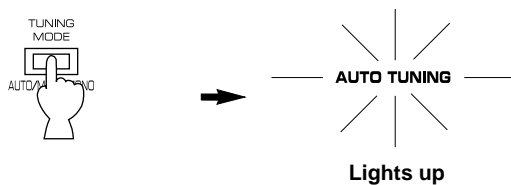

- 3 To tune in to a higher frequency, press the UP side of **TUNING** once.  
To tune in to a lower frequency, press the DOWN side of **TUNING** once.

Front panel

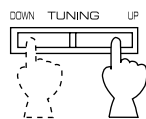

- \* If the station where the tuning search stops is not the desired one, press once more.
- \* If the tuning search does not stop at the desired station (because the signal from the station is weak), take the manual tuning procedure.

## MANUAL TUNING

- 1 Select the reception band (FM or AM) and confirm it on the display.

Front panel

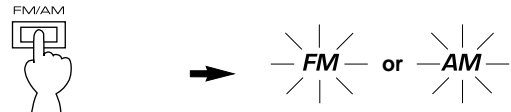

- 2 Press **TUNING MODE**.

Front panel



- 3 Tune in manually to the desired station.

Front panel

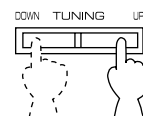

- \* To continue the tuning search, press and hold the button.

### Notes

- If you tune in manually to an FM station, it will be automatically received in monaural mode to increase the signal quality.
- If an RDS station that employs the PS data service is being received, the station name is shown on the display.

## MANUAL PRESET TUNING

This unit can store station frequencies to be selected by tuning. With this function, you can recall any desired station simply by selecting the preset station number with which it was stored. Up to 40 stations (8 stations x 5 groups) can be stored.

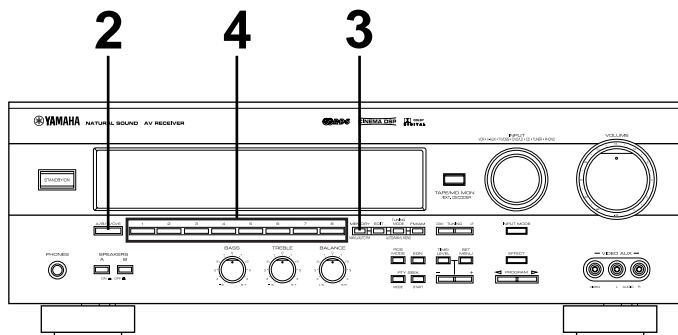

### To store stations

**1** Tune in to the desired station.  
(See the previous page for the tuning procedure.)

---

**2** Press **A/B/C/D/E** once or more to select the desired group (A to E) of preset stations and confirm it on the display.

**Front panel**

**3** Press **MEMORY** so that the “MEMORY” indicator flashes for about five seconds.

**Front panel**

**4** Select the preset station number with which you want to store the station before the “MEMORY” indicator goes off from the display.

**Front panel**

**The displayed station has been stored as A1.**

- \* In the same way, store other stations as A2, A3 ... A8.
- \* You can store more stations as preset station numbers in other groups in the same way by selecting another group in step 2.

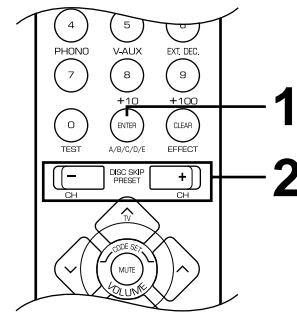
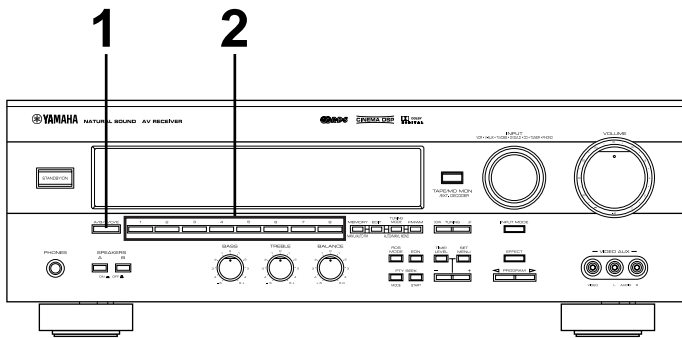

## To recall a preset station

- 1** Select the group of preset stations.

**Front panel**

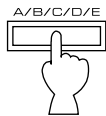

**Remote control**

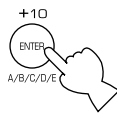

or

- 2** Select the preset station number.

**Front panel**

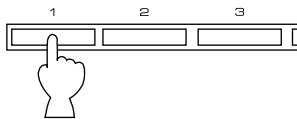

**Remote control**

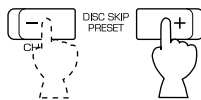

or

### Notes

- A new setting can be stored in place of the former one.
- For presets, the setting of the reception mode (stereo or monaural) is stored along with the station frequency.

### Memory back-up

The memory back-up circuit prevents the stored data from being lost when this unit is set in the standby mode. If, however, the power plug is disconnected from the AC outlet or the power is cut due to temporary power failure for more than one week, the memory will be erased. If so, it can be re-stored by simply following the preset tuning procedure.



## AUTOMATIC PRESET TUNING (for RDS stations only)

You can also make use of the automatic preset tuning function for RDS stations only. This function enables the unit to perform automatic tuning and to sequentially store RDS stations with strong signals. Up to 40 stations can be stored automatically in the same way as that for manual preset tuning on page 31. Note that a new setting can be stored in place of the former one.

\* See pages 35 to 39 for details on RDS stations.

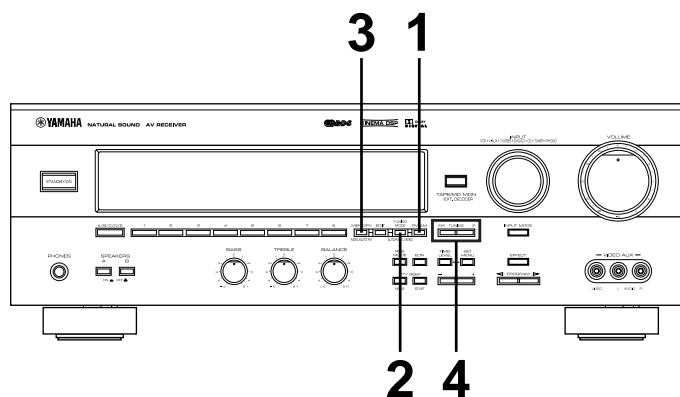

### To store stations

- 1** Select the FM band.

Front panel



- 2** Press **TUNING MODE** so that the “AUTO TUNING” indicator lights up on the display.

Front panel

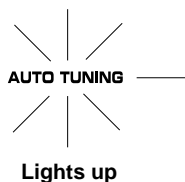
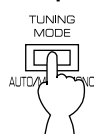

Lights up

- 3** Press **MEMORY** and hold for about three seconds.

Front panel

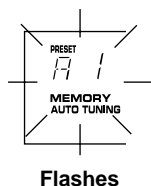

Flashes

- 4** To tune in to higher frequencies, press the UP side of **TUNING** once.  
To tune in to lower frequencies, press the DOWN side of **TUNING** once.

Front panel

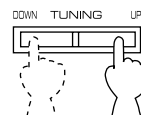

\* If **TUNING** is not pressed, the automatic preset tuning soon begins automatically toward higher frequencies.

Automatic preset tuning begins from the frequency currently displayed. Received stations are sequentially stored as A1, A2 ... A8.

\* If more than 8 stations are received, they are stored as the preset station numbers in other groups (B, C, D and E) in that order.

### If you want to store the first station received by automatic preset tuning as a desired preset station number

For example, if you want to store the first received station as C5, select “C5” while “A1”, the “MEMORY” indicator and the “AUTO TUNING” indicator flash after pressing **MEMORY** in step 3. Then press **TUNING**. The first received station is stored as C5, and the next stations as C6, C7 ... sequentially.

If stations have been stored up to E8, automatic preset tuning automatically stops.

### When automatic preset tuning is complete

The display shows the frequency of the last preset station. Check the contents and the number of preset stations by following the procedure in the section “To recall a preset station” on page 32.

**Notes**

- You can manually replace a preset station with another FM or AM station by simply following the procedure in the section “To store stations” on page 31.
- An automatic preset tuning search will be performed through all RDS network frequencies until stations have been stored up to E8. Even if the number of received stations is not enough to be stored up to E8, the search is automatically ended after searching all frequencies.
- With this function, only RDS stations with sufficient signal strength are automatically stored. If the station you want to store is weak in signal strength, tune in to it manually in monaural sound and store it by following the procedure in the section “To store stations” on page 31.
- \* There may be a case that this function cannot receive a station which could be received by the automatic tuning method. This is because this function receives a large volume of PI (Program Identification) data along with the station.

**EXCHANGING PRESET STATIONS**

You can exchange the assignment of two preset stations with each other as shown below.

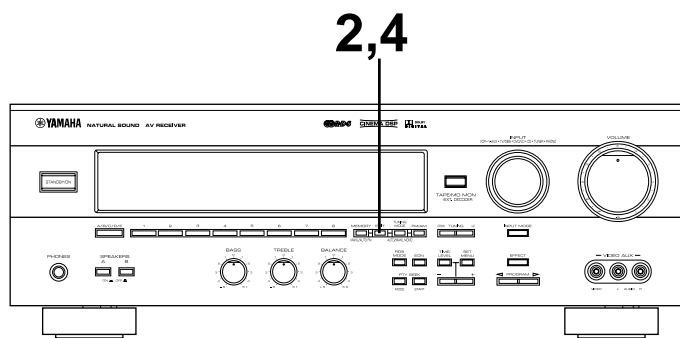

**Example**

If you want to change the preset station from “E1” to “A5”, or vice versa.

**1** Recall preset station “E1” by following the procedure in the section “To recall a preset station” on page 32.

**2** Press **EDIT**.

Front Panel

Flashes

**3** Next, recall preset station “A5” by following the same procedure as in step 1.

Flashes

**4** Press **EDIT** once more.

Front Panel

Shows the exchange of stations has been completed.

The RDS broadcast functions do not operate in areas where RDS broadcasts cannot be received. (In such case, the procedure from pages 35 to 39 is not necessary.)

## RECEIVING RDS STATIONS

Radio Data System (RDS) is a data transmission system gradually being introduced by FM stations in many countries. Stations using this system transmit an inaudible stream of data in addition to the normal radio signal.

RDS data contains various information, such as PI (Program Identification), PS (Program Service name), PTY (Program Type), RT (Radio Text), CT (Clock Time), EON (Enhanced Other Networks), etc.

The RDS function is used by network stations.

### DESCRIPTION OF RDS DATA

This unit can receive PI, PS, PTY, RT, CT, and EON data when receiving RDS broadcast stations.

#### PS (Program Service name) mode:

The name of the RDS station being received is displayed.

#### PTY (Program Type) mode:

The type of program on the RDS station being received is displayed. There are 15 program types to classify RDS stations. You can make this unit search for a station which is broadcasting a program of the desired type. See page 37 for details.

#### RT (Radio Text) mode:

Information about the program (such as the title of a song, name of the singer, etc.) on the RDS station being received is displayed by a maximum of 64 alphabetical characters, including the umlaut sign. If other characters are used for the RT data, they are displayed with under-bars.

#### CT (Clock Time) mode:

The current time is displayed in the following form and updated every minute.

  
 Hour
 

  
 Minute

If the data is accidentally cut off, "CT WAIT" may appear.

#### EON (Enhanced Other Networks):

See page 39.

## CHANGING THE RDS MODE

When an RDS station is received, PS, PTY, RT and/or CT that correspond to the RDS data services employed by the station light up on the display. By pressing **RDS MODE**, you can change the display mode among the RDS modes employed by the received station in the order shown below. Illumination of the RDS mode indicator shows that the corresponding RDS mode has been selected.

- \* When an RDS station is received, do not press **RDS MODE** until one or more names of RDS modes light up on the display. If the button is pressed before one or more names light up on the display, the mode cannot be changed. This is because the unit has not yet received all of the RDS data on the station.
- \* If no RDS mode lights up on the display, the mode cannot be changed.
- \* An RDS mode not employed by the station cannot be selected.

Front panel

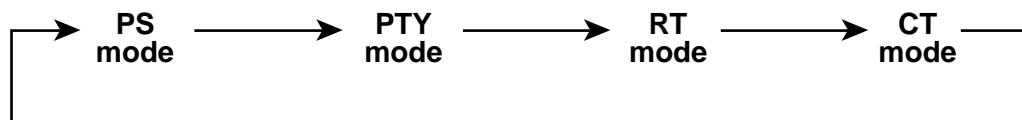

### Notes

- The RDS data service cannot be utilized by this unit if the received signal is not strong enough. In particular, the RT mode requires a large amount of data to be received, so it is possible that the RT mode cannot be displayed even if other RDS modes (PS, PTY, etc.) are displayed.
- There may be a case that RDS data reception is not possible due to poor reception conditions. If so, press **TUNING MODE** so that the "AUTO TUNING" indicator goes off from the display. Although the reception mode is changed to monaural by this operation, when you change the display to RDS mode, RDS data may be displayed.
- If the signal strength is weakened by external interference during the reception of an RDS station, the RDS data service may be cut off suddenly and "...WAIT" will appear on the display.

## PTY SEEK

By designating a program type, the unit automatically searches all preset RDS stations that are broadcasting a program of that type.

\* There are 15 program types to classify RDS stations. See page 38 for details.

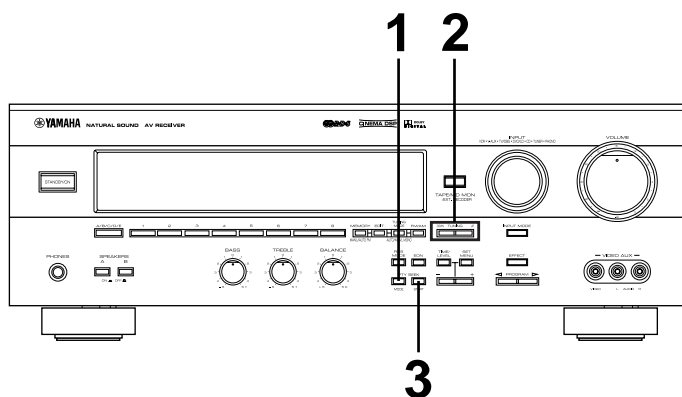

- 1** Press **PTY SEEK MODE** to set the unit in the PTY SEEK mode.

### Front panel

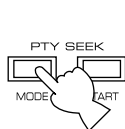

The program type of the station being received or "NEWS" flashes on the display.

- 2** Press **TUNING** (Up side or Down side) to select the desired program type.

### Front panel

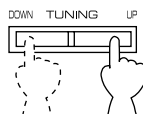

- 3** Press **PTY SEEK START** to begin searching all preset RDS stations.

### Front panel

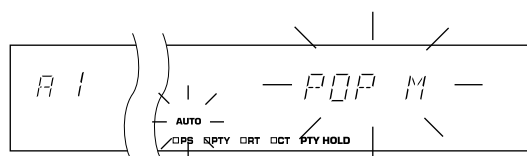
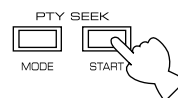

Flashes

- \* The "PTY HOLD" indicator lights up on the display.
- \* If the station that is broadcasting a program of the required type is found, the unit stops at the station and displays the frequency of the station.
- \* If the called station is not the desired one, press **PTY SEEK START** once more. The unit begins searching for another station that is broadcasting a program of the same type.

### To cancel this function

Press **PTY SEEK MODE** twice.

## PROGRAM TYPES IN THE PTY MODE

### **NEWS**

#### **News:**

Short accounts of facts, events and publicly expressed views, reportage and actuality.

### **AFFAIRS**

#### **Current affairs:**

Topical program expanding or enlarging upon the news, generally in different presentation style or concept, including documentary debate, or analysis.

### **INFO**

#### **Information:**

Program whose purpose is to impart advice in the widest sense, including meteorological reports and forecasts, consumer affairs, medical help, etc.

### **SPORT**

#### **Sport:**

Program concerned with any aspect of sport.

### **EDUCATE**

#### **Education:**

Program intended primarily to educate, of which the formal element is fundamental.

### **DRAMA**

#### **Drama:**

All radio plays and serials.

### **CULTURE**

#### **Culture:**

Programs concerned with any aspect of national or regional culture, including religious affairs, philosophy, social science, language, theatre, etc.

### **SCIENCE**

#### **Science:**

Programs about the natural sciences and technology.

### **VARIED**

#### **Varied:**

Used for mainly speech-based programs usually of light-entertainment nature, not covered by above categories. Examples are: quizzes, panel games, personality interviews, comedy and satire.

### **POP M**

#### **Pop:**

Commercial music, which would generally be considered to be of current popular appeal, often featuring in current or recent record sales charts.

### **ROCK M**

#### **Rock:**

Contemporary modern music, usually written and performed by young musicians.

### **M.O.R. M**

#### **M.O.R.:**

(Middle of the Road Music). Common term to describe music considered to be "easy-listening", as opposed to Pop, Rock or Classical. Music in this category is often but not always, vocal, and usually of short duration (<5 min.)

### **LIGHT M**

#### **Light classics:**

Classical Musical for general, rather than specialist appreciation. Examples of music in this category are instrumental music, and vocal or choral works.

### **CLASSICS**

#### **Serious classics:**

Performances of major orchestral works, symphonies, chamber music etc., and including Grand Opera.

### **OTHER M**

#### **Other music:**

Musical styles not fitting into any of the above categories. Particularly used for specialist music, of which Jazz, Rhythm & Blues, Folk, Country, and Reggae are examples.

## EON FUNCTION

This function uses the EON data service on the RDS station network.

By simply selecting the desired program type (NEWS, INFO, AFFAIRS or SPORT), the unit will automatically monitor all preset RDS stations that broadcast a program of that type and switch from the program being currently received to that program when the broadcast starts.

\* This function can only be used when an RDS station that employs the EON data service is being received. (When such a station is received, the "EON" indicator lights up on the display.)

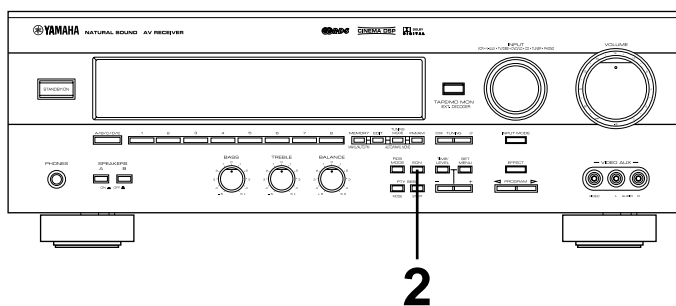

- 1** Make sure that the "EON" indicator lights up on the display.

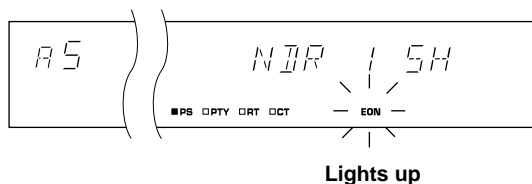

\* If the "EON" indicator does not light up on the display, tune in to another RDS station so that the "EON" indicator lights up.

- 2** Press **EON** once or more to select the desired program type, NEWS, INFO, AFFAIRS or SPORT.

Front panel

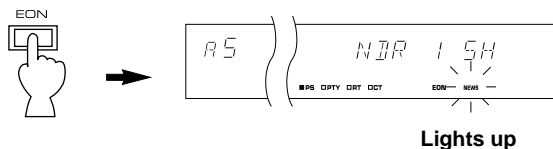

If a preset RDS program of the designated type starts broadcasting, the unit will automatically switch from the program being currently received to that program.

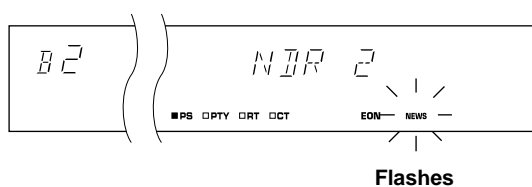

- 3** When broadcasting of the selected program ends, the previously received program (or another program on the same station) is recalled.

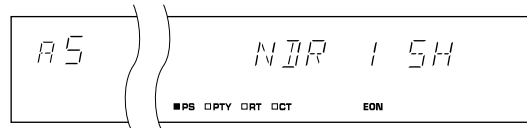

### To cancel this function

Press **EON** once or more so that no program type name lights up on the display.

# SETTING THE SLEEP TIMER

The SLEEP timer can be used to make this unit automatically switch to the standby mode. When you are going to sleep while enjoying a broadcast or other desired program source, this timer function is useful. The SLEEP timer can only be controlled with the remote control transmitter.

## Notes

- To set the SLEEP timer for this unit, press **AMP<TUNER>**, **TAPE/MD**, **CD** or **DVD/LD** on the component selector.
- The components for which the SLEEP timer is effective are the sources connected to the **SWITCHED AC OUTLET(S)** on the rear panel of this unit.

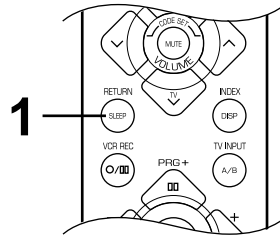

## To set the SLEEP time

- 1 Press **SLEEP** once or more to select the desired SLEEP time.

### Remote control



The SLEEP time is displayed.

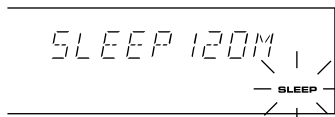

Flashes

Each time you press **SLEEP**, the SLEEP time will change as follows:

(Minutes)

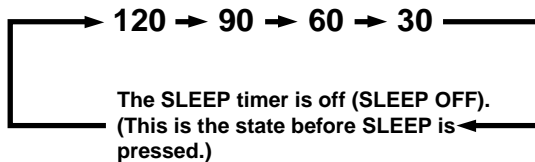

The "SLEEP" indicator soon lights up and the display returns to the indication before the SLEEP timer was set.

- 2 The unit will be switched to the standby mode automatically at the selected SLEEP time.

## To cancel the selected SLEEP time

### Remote control



Press **SLEEP** once or more so that "SLEEP OFF" appears on the display. (It will soon disappear and the "SLEEP" indicator will go off from the display.)

### Note

The SLEEP timer setting can also be canceled by setting the unit in the standby mode with **STANDBY/ON** on the front panel (or **POWER** on the remote control transmitter) or by disconnecting the power plug of the unit from the AC outlet.



# USING THE DIGITAL SOUND FIELD PROCESSOR (DSP)

This unit incorporates a sophisticated, multi-program digital sound field processor. The processor allows you to electronically expand and change the shape of the audio sound field from both audio and video sources, creating a theater-like experience in your listening room. You can create outstanding audio sound by selecting a suitable sound field program (this will, of course, depend on what you are listening to) and adding any desired adjustments.

The following list gives you a brief description of the sound fields produced by each of the DSP programs. Keep in mind that most of these are precise digital re-creations of actual acoustic environments. The data for these sound fields were recorded at actual locations using sophisticated sound field measurement equipment.

## Note

The channel level balance between the left and right rear speakers may vary depending on the sound field you are listening to. This is due to the fact that most of these sound fields are a re-creation of actual acoustic environments.

## BRIEF OVERVIEW OF DIGITAL SOUND FIELD PROGRAMS

No.	PROGRAM	FEATURES
1	<p><b>DOLBY PRO LOGIC</b> ( <input checked="" type="checkbox"/> PRO LOGIC )</p> <p>This functions when the input signal is analog or PCM audio, or encoded with Dolby Digital in 2-channel. Speaker output: main, center, rear</p> <p><b>DOLBY DIGITAL</b> ( <input checked="" type="checkbox"/> DIGITAL )</p> <p>This functions when the input signal is encoded with Dolby Digital (not in 2-channel). Speaker output: main, center, rear</p>	<p>This reproduces video discs, video tapes and similar sources which are Dolby Surround encoded and bear the "DOLBY SURROUND" logo.</p> <p>The built-in Dolby Pro Logic Surround decoder or Dolby Digital decoder precisely reproduces the sounds and sound effects of a source encoded with Dolby Surround. The realization of a highly efficient decoding process improves crosstalk and channel separation and makes sound positioning smoother and more precise.</p> <p><b>Note:</b> If the main channel sound is considerably altered by overadjusting <b>BASS</b> or <b>TREBLE</b>, it may not produce suitable surround sound.</p>
2	<p><b>DOLBY PRO LOGIC ENHANCED</b> ( <input checked="" type="checkbox"/> DSP <input checked="" type="checkbox"/> PRO LOGIC )</p> <p>This functions when the input signal is analog or PCM audio, or encoded with Dolby Digital in 2-channel. Speaker output: main, center, rear</p> <p><b>DOLBY DIGITAL ENHANCED</b> ( <input checked="" type="checkbox"/> DIGITAL <input checked="" type="checkbox"/> DSP )</p> <p>This functions when the input signal is encoded with Dolby Digital (not in 2-channel). Speaker output: main, center, rear</p>	<p>This reproduces video discs, video tapes and similar sources which are Dolby Surround encoded and bear the "DOLBY SURROUND" logo.</p> <p>This program ideally simulates the multi-surround speaker systems of the 35 mm film theater. Dolby Surround decoding is precisely performed without altering the original sound orientation. The surround effects produced by this sound field fold around the viewer naturally from the rear to the left and right and toward the screen.</p>
3	<p><b>70 mm MOVIE THEATER</b> ( <input checked="" type="checkbox"/> DSP <input checked="" type="checkbox"/> PRO LOGIC )</p> <p>This functions when the input signal is analog or PCM audio, or encoded with Dolby Digital in 2-channel. Speaker output: main, center, rear</p> <p><b>DIGITAL MOVIE THEATER</b> ( <input checked="" type="checkbox"/> DIGITAL <input checked="" type="checkbox"/> DSP )</p> <p>This functions when the input signal is encoded with Dolby Digital (not in 2-channel). Speaker output: main, center, rear</p>	<p>This is ideal for reproducing video discs, video tapes and similar sources which are Dolby Surround encoded and bear the "DOLBY SURROUND" logo.</p> <p>This program is ideal for precisely reproducing the sound design of the newest 70 mm/Dolby Digital multi-track films. The sound field is similar to that of the newest movie theaters, so the reverberations of the sound field itself are restrained as much as possible. The three-dimensional feeling of the sound field is emphasized, and dialog is precisely oriented on the screen. You can enjoy watching Sci-Fi, adventure movies, etc. with considerable presence.</p>

No.	PROGRAM	FEATURES
4	<p><b>MONO MOVIE</b> ( <b>DSP</b> )</p> <p>This functions when the input signal is analog or PCM audio, or encoded with Dolby Digital in 2-channel. Speaker output: main, center, rear</p> <p>( <b>DIGITAL DSP</b> )</p> <p>This functions when the input signal is encoded with Dolby Digital (not in 2-channel). Speaker output: main, center, rear</p>	<p>This program is designed specifically to enhance mono audio sources. Compared to a strictly mono setting, the sound image created in this mode is wider and slightly forward of the speaker pair, lending an immediacy to the overall sound. It is particularly effective when used with old mono movies, news broadcasting and dialog.</p>
5	<p><b>TV SPORTS</b> ( <b>DSP</b> )</p> <p>This functions when the input signal is analog or PCM audio, or encoded with Dolby Digital in 2-channel. Speaker output: main, center, rear</p> <p>( <b>DIGITAL DSP</b> )</p> <p>This functions when the input signal is encoded with Dolby Digital (not in 2-channel). Speaker output: main, center, rear</p>	<p>This program is furnished with a tight sound field in which the sound will not spread excessively on the front side, but the rear surround side produces dynamic sound expansion. This program is the most suitable for sports events.</p>
6	<p><b>DISCO</b> ( <b>DSP</b> )</p> <p>This functions when the input signal is analog or PCM audio, or encoded with Dolby Digital in 2-channel. Speaker output: main, rear</p> <p>( <b>DIGITAL DSP</b> )</p> <p>This functions when the input signal is encoded with Dolby Digital (not in 2-channel). Speaker output: main, center, rear</p>	<p>This program re-creates the acoustic environment of a lively disco in the heart of a very lively city. The sound is dense and highly concentrated. It is also characterized by a high-energy, "immediate" sound.</p>
7	<p><b>ROCK CONCERT</b> ( <b>DSP</b> )</p> <p>This functions when the input signal is analog or PCM audio, or encoded with Dolby Digital in 2-channel. Speaker output: main, rear</p> <p>( <b>DIGITAL DSP</b> )</p> <p>This functions when the input signal is encoded with Dolby Digital (not in 2-channel). Speaker output: main, center, rear</p>	<p>This program is ideally suited for rock music. You will experience a very dynamic and lively sound field.</p>
8	<p><b>CONCERT HALL</b> ( <b>DSP</b> )</p> <p>This functions when the input signal is analog or PCM audio, or encoded with Dolby Digital in 2-channel. Speaker output: main, rear</p> <p>( <b>DIGITAL DSP</b> )</p> <p>This functions when the input signal is encoded with Dolby Digital (not in 2-channel). Speaker output: main, center, rear</p>	<p>In this program, the center will appear to be deep behind the main speakers, creating an expansive, large hall ambience. Orchestra and opera music are suited to this sound field.</p>

**Note:** When the NONE position is selected for "CNTR" in the SET MENU mode, no sound is output from the center speaker(s).

## PLAYING AN AUDIO/VIDEO SOURCE WITH THE DIGITAL SOUND FIELD PROCESSOR (DSP) EFFECT

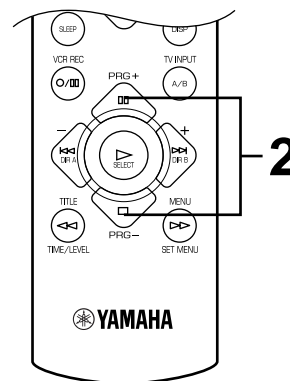
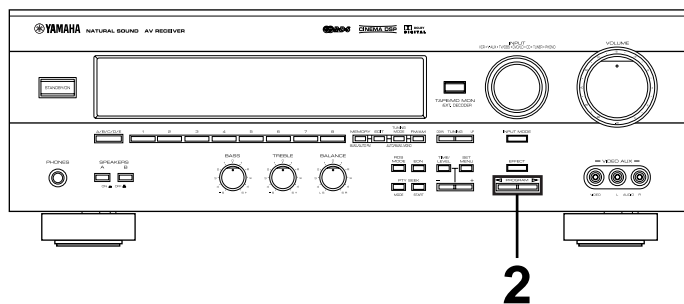

**1** Follow steps 1 to 7 shown in "BASIC OPERATIONS" on pages 26 to 27.

**2** Select the desired DSP program that is suitable for the source. When using the remote control transmitter, press **AMP<TUNER>** on the component selector first.

### Front panel

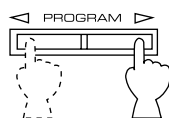

or

### Remote control

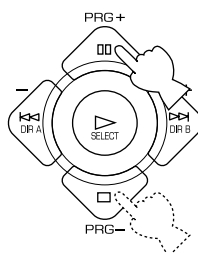

The name of the selected program appears on the display.

**3** If desired, adjust the delay time and the output level of each speaker. (See pages 45 and 46 for details.)

### Notes

- You can select a program for each of the program sources. Once you select a program, it is linked with the program source selected at that time. So, when you select the program source next time, the same program is automatically called.
- If you prefer to cancel the DSP function, press **EFFECT**. The sound will be that of normal 2-channel stereo without a surround sound effect.
- When a monaural sound source is played with **DOLBY PRO LOGIC** or **DOLBY PRO LOGIC ENHANCED**, no sound can be heard from the main speakers and the rear speakers. Sound is heard only from the center speaker. However, if the NONE position is selected for "CNTR" in the SET MENU mode, the main speakers output the sound of the center channel.

This unit incorporates a Dolby Digital decoder and a Dolby Pro Logic Surround decoder for multi-channel sound reproduction of sources encoded with Dolby Surround. The operation of these decoders can be controlled by selecting a corresponding DSP program including the combined operation of YAMAHA DSP and Dolby Digital or Dolby Pro Logic Surround.

### To enjoy a video source with Dolby Pro Logic Surround or Dolby Digital-decoded

When you select the **DOLBY PRO LOGIC/DOLBY DIGITAL**, **DOLBY PRO LOGIC ENHANCED/DOLBY DIGITAL ENHANCED** or **70 mm MOVIE THEATER/DIGITAL MOVIE THEATER** program, and the input signal of the source is 2-channel stereo, Dolby Pro Logic Surround is decoded. When a program is selected and the input signal of the source is encoded with Dolby Digital, Dolby Digital is automatically decoded.

\* The following indicators on the display show you what sound processing is being undertaken.

This lights up when Dolby Digital is being decoded and the input signal of the selected source encoded with Dolby Digital is not in 2-channel.

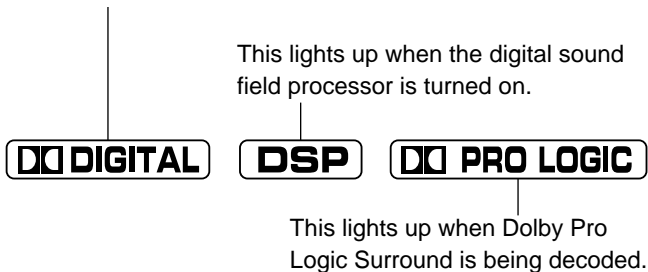

\* In addition, for the **DOLBY PRO LOGIC/DOLBY DIGITAL**, **DOLBY PRO LOGIC ENHANCED/DOLBY DIGITAL ENHANCED** or **70 mm MOVIE THEATER/DIGITAL MOVIE THEATER** program, the name of the program on the display will change according to the type of decoding. (See page 41 for details.)

#### Note

If the input signal of the source is encoded with Dolby Digital in 2-channel only, their sound processing is similar to that for analog or PCM audio signals.

### To cancel the sound effect

**EFFECT** on the front panel and on the remote control transmitter make it simple to compare the normal stereo sound with the fully processed sound effect.

To cancel the sound effect and monitor only the main sound, press **EFFECT**. Press **EFFECT** once more to turn sound effect on.

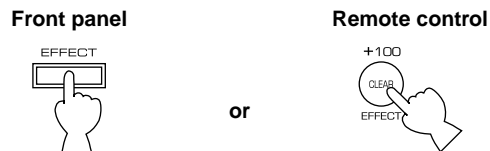

#### Notes

- If the sound effect is canceled when signals encoded with Dolby Digital are input to this unit, the signals of all channels are mixed and are output from the main speakers.
- If **EFFECT** is pressed to turn sound effects off when Dolby Digital is decoded, it may happen that the sound is output faintly or not output normally, depending on the source. In that case, press **EFFECT** to turn sound effects on, or use input signals not encoded with Dolby Digital.

# ADJUSTING THE DELAY TIME AND SPEAKER OUTPUT LEVELS

When using the digital sound field processor with the Dolby Pro Logic Surround decoder or the Dolby Digital decoder, you can adjust the delay time between the main sound and sound effect, and each speaker's output level as you prefer.

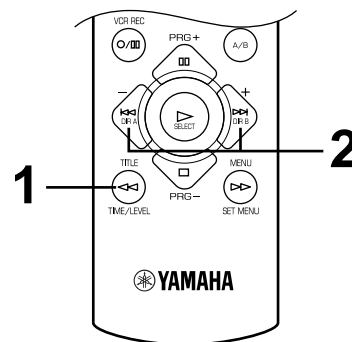
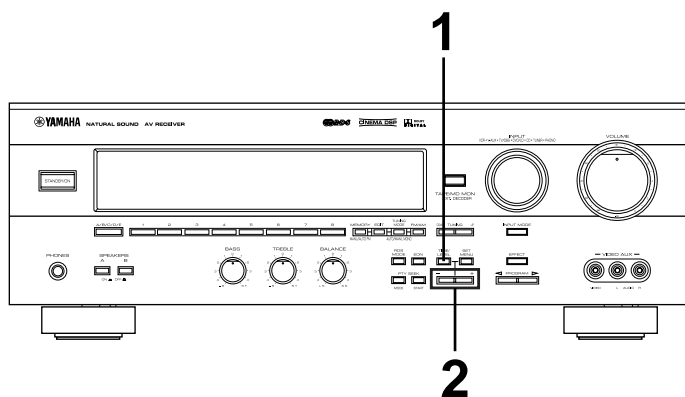

## Adjusting method

When adjusting with the remote control transmitter, press **AMP<TUNER>** on the component selector.



**2** Press + or – to adjust the settings for the delay time or speaker output levels.

Front panel

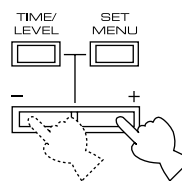

Remote control

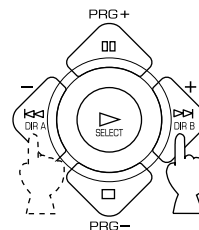

**1** Press **TIME/LEVEL** once or more until the name of the item which you want to adjust appears on the display.

Front panel

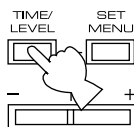

Remote control



or

**3** Repeat steps 1 to 2 to adjust the settings of any other item.

When pressed, the selection changes as follows:

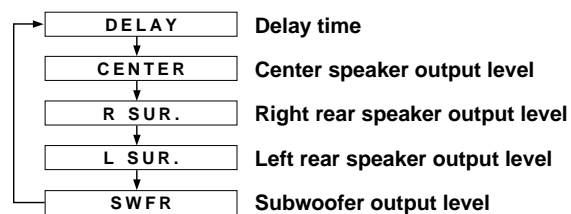

\* Depending on the setting in the SET MENU mode, you may not be able to select all items.

## Adjusting the delay time

You can adjust the time difference between the beginning of the sound from the main speakers and the beginning of the sound effect from the rear speakers.

The larger the value, the later the sound effect is generated. This adjustment can be individually made to all programs.

### Notes

- Adding too much delay will cause an unnatural effect with some sources.
- When + or – is pressed, the sound is momentarily interrupted.

Program	Control range (ms)	Preset value
1. DOLBY PRO LOGIC	15 to 30	20
DOLBY DIGITAL	0 to 15	5
2. DOLBY PRO LOGIC ENHANCED	15 to 30	20
DOLBY DIGITAL ENHANCED	0 to 15	5
3. 70 mm MOVIE THEATER	15 to 30	20
DIGITAL MOVIE THEATER	1 to 99	16
4. MONO MOVIE	1 to 99	49
5. TV SPORTS	1 to 99	9
6. DISCO	1 to 99	40
7. ROCK CONCERT	1 to 99	16
8. CONCERT HALL	1 to 99	44

---

## Adjusting the output level of the center, right rear and left rear speakers, and subwoofer

If desired, you can adjust the sound output level of each speaker even if the output level has already been set in "SPEAKER BALANCE ADJUSTMENT" on pages 23 to 25.

### Notes

- The output level of the center speaker cannot be adjusted when the **DISCO**, **ROCK CONCERT** or **CONCERT HALL** program is selected, and the input signal is analog, PCM audio, or encoded with Dolby Digital in 2-channel format.

- If the function "CNTR" in the SET MENU mode is set to the NONE position, the sound output level of the center speaker cannot be adjusted. This is because, in this mode, the center sound is automatically output from the left and right main speakers.
- Once the output level has been adjusted, the level will be the same for all digital sound field programs.

Speakers	Control range (dB)	Preset value
CENTER	MIN, -20 to +10	0
RIGHT REAR	MIN, -20 to +10	0
LEFT REAR	MIN, -20 to +10	0
SUBWOOFER	MIN, -20 to 0	0

---

## Memory back-up

The memory back-up circuit prevents the stored data from being lost when this unit is set in the standby mode. If, however, the power plug is disconnected from the AC outlet or the power is cut due to temporary power failure for more than one week, the values for the delay time and the center/rear/subwoofer output levels you set the last time will automatically return to the preset values. If so, they can be re-set by simply following the adjusting method on page 45.

# ADJUSTMENTS IN THE “SET MENU” MODE

The following ten types of functions maximize the performance of your system and expand your enjoyment for audio listening and video watching.

1. **CNTR (CENTER SPEAKER)**
2. **REAR (REAR SPEAKERS)**
3. **MAIN (MAIN SPEAKERS)**
4. **BASS (LFE/BASS OUT)**
5. **M.LVL (MAIN LEVEL)**
6. **LFE (LFE LEVEL)**
7. **D.RNG (DYNAMIC RANGE)**
8. **C.DELAY (CENTER DELAY)**
9. **GUARD (MEMORY GUARD)**
10. **INPUT (INPUT MODE)**

For details on “CNTR”, “REAR”, “MAIN”, “BASS” and “M.LVL”, see page 21. (Once you have selected the appropriate modes, you do not have to change settings unless any alteration is made in your speaker system.)

## LFE [Adjusting the output level of the LFE (low frequency effect) channel]

**Control range: –20 dB to 0 dB (in 1 dB steps)**

**Preset value: 0 dB**

\* This adjustment is effective only when Dolby Digital is decoded and the signals of the selected source encoded with Dolby Digital contain LFE signals.

This adjusts the output level of the LFE channel. If the LFE signals are mixed with signals of other channels to output them from the same speakers, the ratio of the LFE signal level to the level of the other signals is adjusted.

(See page 5 for details about the LFE channel.)

## D.RNG (Adjusting the dynamic range)

**Choices: MAX/STD/MIN**

**Preset position: MAX**

\* This adjustment is effective only when Dolby Digital is decoded.

**MAX:** “Dynamic range” is the difference between the maximum level and the minimum level of sounds. Sounds on a movie originally designed for movie theaters feature very wide dynamic range. Dolby Digital technology can modify the original sound track into a home audio format with this wide dynamic range unchanged. In this position, a source encoded with Dolby Digital is reproduced in the original sound track’s wide dynamic range providing you with powerful sounds just like those in a movie theater. Selecting this position will be even better if you can listen to a source at a high output level in a room specially soundproofed for audio/video enjoyment.

### STD (Standard):

Powerful sounds of extremely wide dynamic range are not always suitable for home use. Depending on the condition of your listening environment, it may not be possible to increase the sound output level as high as that in a movie theater. However, at the normal level suitable for listening to in your room, the low-level parts of source sound often cannot be heard well because they will be lost among noise in your environment. Dolby Digital technology has also made it possible to reduce an original sound track’s dynamic range for a home audio format by “compressing” the sound data.

In this position, a source encoded with sound Dolby Digital is reproduced in the “compressed” dynamic range of sound that is suitable for low-level listening.

**MIN:** In this position, the dynamic range is more reduced than in the STD position.

Selecting this position will be effective when you must listen to a source at a low level.

## C.DELAY [Adjusting the delay of center sounds (dialog, etc.)]

**Control range: 0 ms to 5 ms (in 1 ms steps)**  
**Preset value: 0 ms**

- \* This adjustment is effective only when Dolby Digital is decoded and the signals of the selected source encoded with Dolby Digital contain center-channel signals.

This adjusts the delay between the main sound (on the main channels) and dialog, etc. (on the center channel). The larger the value, the later the dialog, etc. is generated.

This is for making sounds from the left main, center and right main speakers reach your listening position at the same time. This is achieved by delaying the sound from the center speaker if the distance from the center speaker to your listening position is shorter than the distance from the left or right main speaker to your listening position.

## GUARD

**Choices: ON/OFF**  
**Preset position: OFF**

If you wish to prevent accidental alterations to SET MENU and other adjustments on this unit, select ON. The following functions on this unit can be locked by this operation:

- Functions in the SET MENU mode
- Functions in the TIME/LEVEL mode
- Functions when using **TEST**

## INPUT (Selecting the initial input mode of the sources connected to the TV/DBS input terminals)

**Choices: AUTO/LAST**  
**Preset position: AUTO**

You can designate the input mode that is automatically selected when the power for this unit is switched on for only the sources connected to the TV/DBS input terminals of this unit.

- AUTO:** In this position, the AUTO input mode is always selected when the power for this unit is switched on.
- LAST:** In this position, the input mode you selected last time is memorized and will not be changed when the power is switched on again.

- \* See page 28 for details on switching the input mode.

## Adjusting method

Adjustments should be made while watching the information on this unit's display.

When adjusting with the remote control transmitter, press **AMP<TUNER>** on the component selector.



Press **SET MENU** once or more so that the function which you want to change appears on the display.

### Front panel

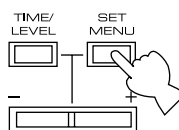

or

### Remote control

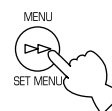

Press **+** or **-** to select any desired setting or to edit parameters of the function.

### Front panel

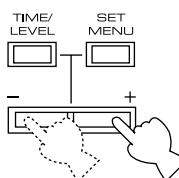

or

### Remote control

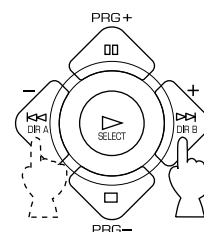

Repeat these steps to change or adjust the settings of any other function.

## Memory back-up

The memory back-up circuit prevents the stored data from being lost when this unit is set in the standby mode. If, however, the power plug is disconnected from the AC outlet or the power is cut due to temporary power failure for more than one week, the settings of the SET MENU mode will automatically return to the factory settings. If so, they can be re-set by simply following the procedure above.



# REMOTE CONTROL TRANSMITTER

You can use the remote control transmitter to control not only this unit but also other components connected to it. The remote control transmitter is factory set to control this unit and most YAMAHA audio components. To control other brands of components, you must preset the remote control transmitter with manufacturers' codes listed on pages 411 to 416.

## Components which can be controlled

There are eight buttons on the component selector that you can select to control connected components with this remote control transmitter. For example, if **CD** on the component selector is pressed, the remote control transmitter selects the CD operation mode, allowing the CD player to be operated by the buttons on the remote control transmitter.

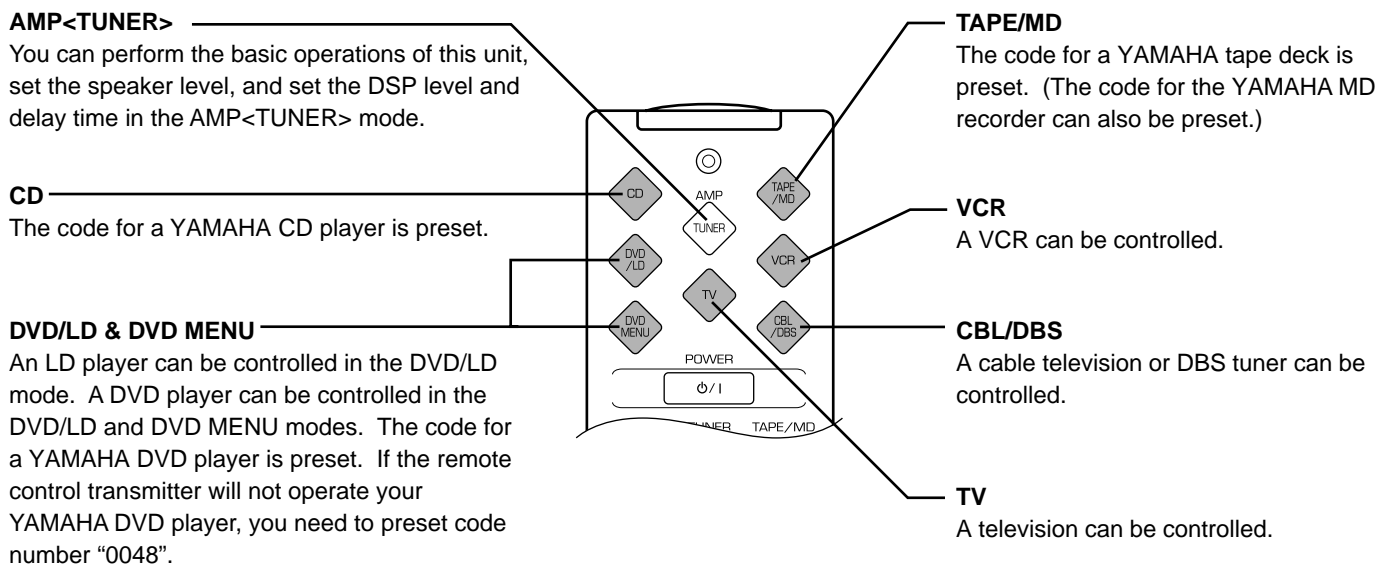

### Notes

1. You can preset the code for the manufacturer of your component after pressing the shaded buttons in the illustration above. Note that you can preset only one code for one mode. See "SETUP CODES" on page 56 for details.
2. In the DVD/LD and DVD MENU modes:
  - Be sure to press **DVD/LD** on the component selector before presetting the code for the DVD/LD player. The code preset in the DVD/LD mode is also simultaneously preset in the DVD MENU mode. You cannot preset the code for a DVD player in the DVD MENU mode.
  - DVD MENU operations cannot be performed for some DVD players.
3. When using a second (and third) VCR: (See "To use a second (and third) VCR" on page 56 for details.)
  - If you are not using a CBL/DBS (cable TV or DBS tuner), the second (or third) VCR can be preset in the CBL/DBS mode.
  - If you are not using a DVD player, the second (or third) VCR can be preset in the DVD MENU mode. Note that in this case you must preset the code for an LD player in the DVD/LD mode even if an LD player is not being used.

The lightly marked buttons do not function.

## AMP<TUNER> MODE

Note: TV VOLUME and TV INPUT function if you have preset the code for your TV.

Press AMP<TUNER>.

### POWER

Each time this button is pressed, the unit will switch between the power on and standby modes.

### TEST

This button outputs a test tone for adjusting the output levels of the speakers.

### A/B/C/D/E & PRESET +/-

These buttons select a preset FM (RDS) or AM broadcast.

A/B/C/D/E: To select a group of preset stations.

PRESET +/-: To select the preset station number.

### MUTE

This button mutes the sound. To cancel mute, press this button once more, or press any operation buttons of this unit.

### VOLUME ( ^ v )

These buttons adjust the volume level.

### SLEEP

This button sets the SLEEP timer.

### +/-

These buttons adjust the settings of the SET MENU mode and the TIME/LEVEL mode.

### TIME/LEVEL

This button selects the item in the TIME/LEVEL mode.

### Input selector

These buttons select the program source.

CD: To play a CD

TUNER: To listen to an FM (RDS) or AM broadcast

TAPE/MD: To play a tape or MD

DVD/LD: To play a DVD or LD

TV/DBS: To watch a television or satellite broadcast

VCR: To play a video tape

PHONO: To play an analog record

V-AUX: To use a camcorder

EXT. DEC.: To output the signals of a DTS or other multi-channel decoder

### EFFECT

This button switches the DSP program on or off.

### TV VOLUME

### TV INPUT

### PRG+/PRG-

These buttons select a DSP program.

### SET MENU

This button selects functions in the SET MENU mode.

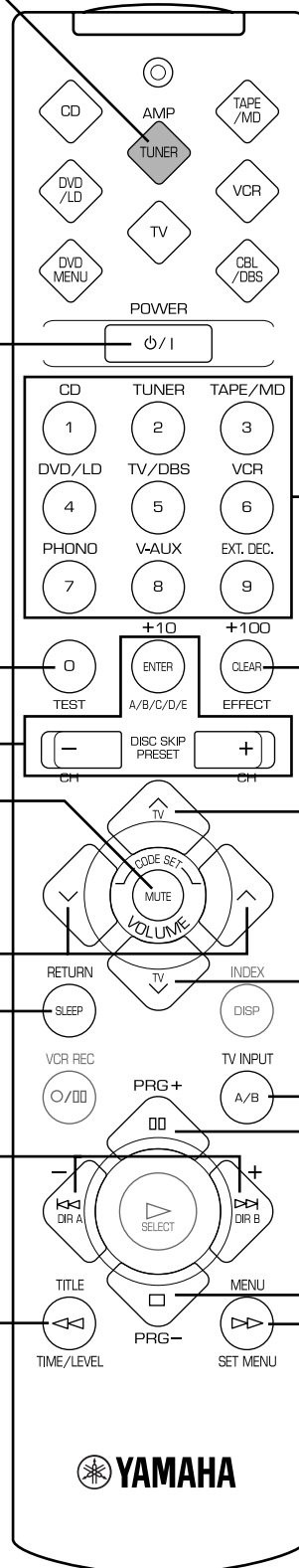

The lightly marked buttons do not function. Please refer to the owner's manual for details of each component.

**TAPE/MD MODE**

- Notes:**
- **TV VOLUME** functions if you have preset the code for your TV.
  - The code for the YAMAHA MD recorder can be preset.

**POWER**

**(TAPE)** When you have preset the code for a YAMAHA tape deck, this button turns the unit on. When you have preset the code for another manufacturer, this button turns on that component if it has a remote control transmitter with a power button.

**(MD)** When you have preset the code for the YAMAHA MD recorder, this button turns the unit on.

**REC/PAUSE**

This button pauses recording on a tape deck or MD recorder.

**PLAY**

This button plays a tape or an MD.

**DIR A (TAPE)**

This button selects the playing direction of deck A.

**SKIP- (MD)**

This button skips to the previous track.

**REWIND (TAPE)**

This button rewinds a tape.

**SEARCH (MD)**

This button initiates a backward on the track that is playing to find the point from which you want to listen.

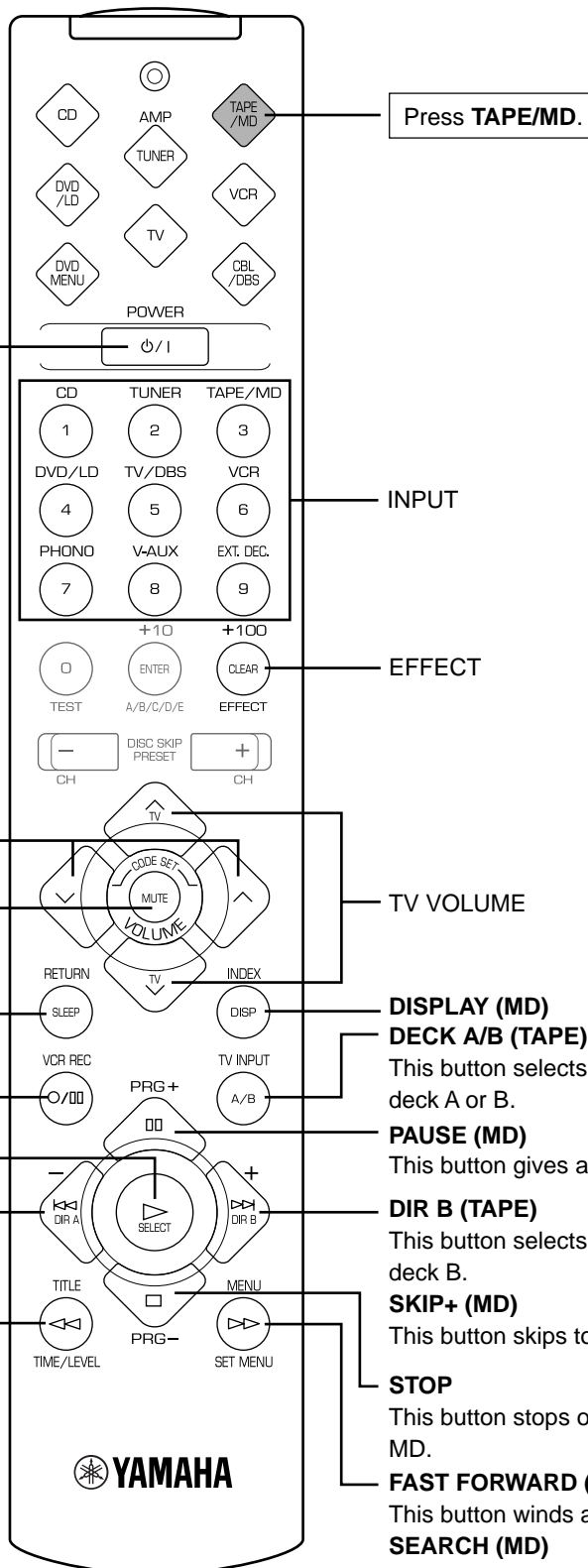

Press TAPE/MD.

INPUT

EFFECT

VOLUME

MUTE

SLEEP

TV VOLUME

DISPLAY (MD)

DECK A/B (TAPE)

This button selects double-cassette tape deck A or B.

PAUSE (MD)

This button gives a pause in operation.

DIR B (TAPE)

This button selects the playing direction of deck B.

SKIP+ (MD)

This button skips to the next track.

STOP

This button stops operation of a tape or MD.

FAST FORWARD (TAPE)

This button winds a tape fast forward.

SEARCH (MD)

This button initiates a fast-forward search on the track that is playing to find the point from which you want to listen.

The lightly marked buttons do not function. Please refer to the owner's manual for details of each component.

■ CD MODE

Note: TV VOLUME and TV INPUT function if you have preset the code for your TV.

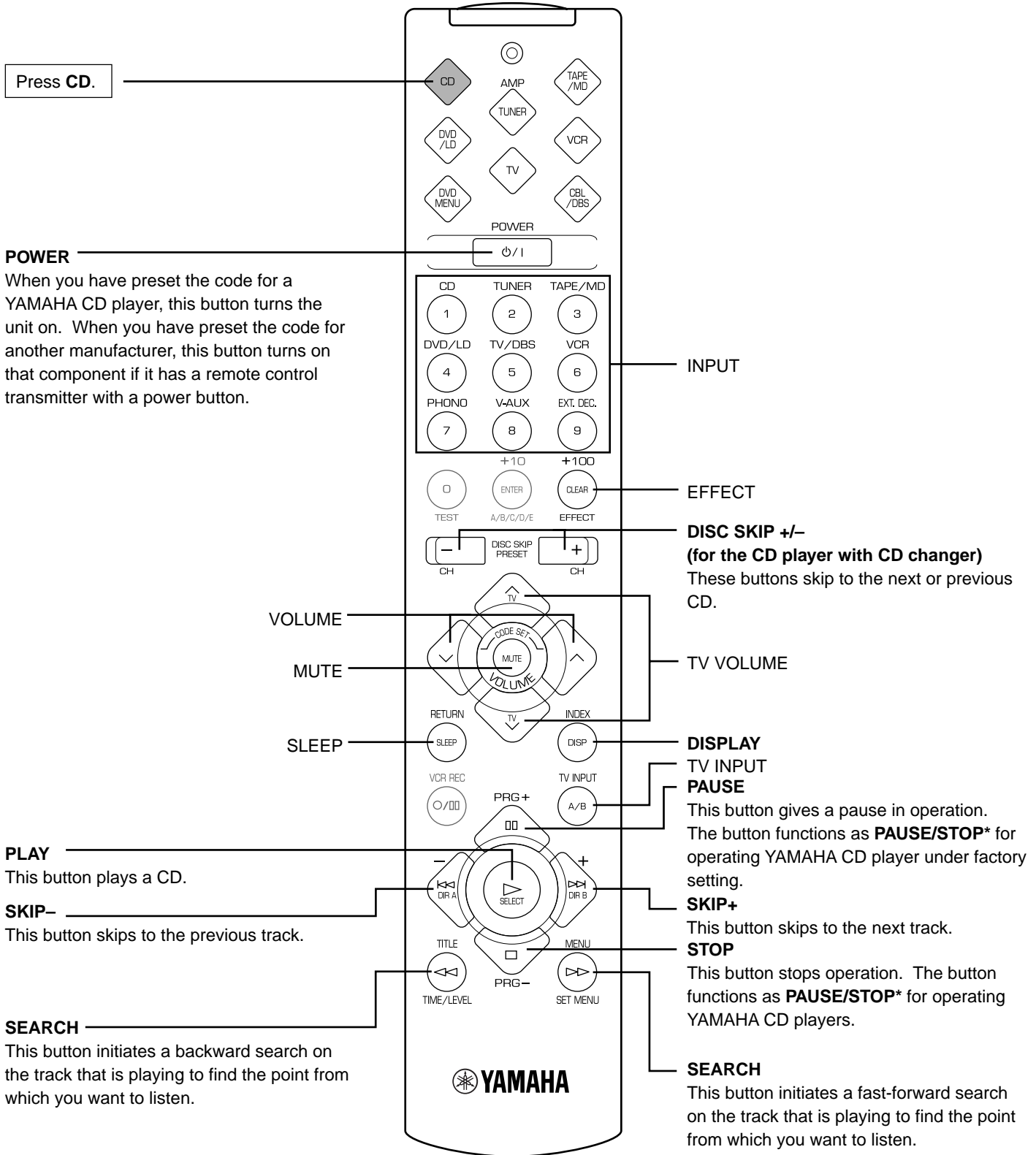

\* **PAUSE/STOP** function ... Press the button once to give a pause in operation and once more to stop operation.

The lightly marked buttons do not function. Please refer to the owner's manual for details of each component.

### DVD/LD MODE

Press **DVD/LD**.

**POWER**  
**(DVD)** When you have preset the code for a YAMAHA DVD player, this button turns the unit on. When you have preset the code for another manufacturer, this button turns on that component if it has a remote control transmitter with a power button.  
**(LD)** When you have preset the code for a YAMAHA LD player, this button turns the unit on. When you have preset the code for another manufacturer, this button turns on that component if it has a remote control transmitter with a power button.

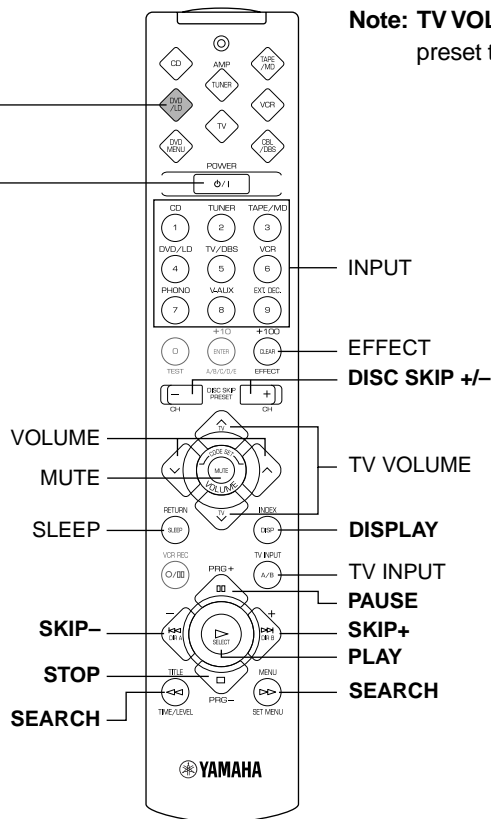

**Note:** TV VOLUME and TV INPUT function if you have preset the code for your TV.

### DVD MENU MODE

Press **DVD MENU**.

**POWER**  
 When you have preset the code for a YAMAHA DVD player, this button turns the unit on. When you have preset the code for another manufacturer, this button turns on that component if it has a remote control transmitter with a power button.

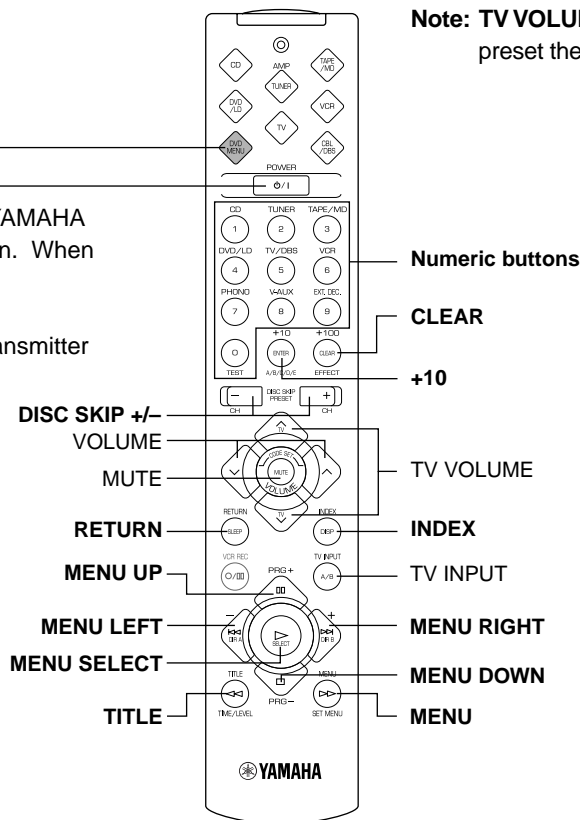

**Note:** TV VOLUME and TV INPUT function if you have preset the code for your TV.

The lightly marked buttons do not function. Please refer to the owner's manual for details of each component.

### VCR MODE

**Note:** TV VOLUME, TV INPUT and TV SLEEP function if you have preset the code for your TV.

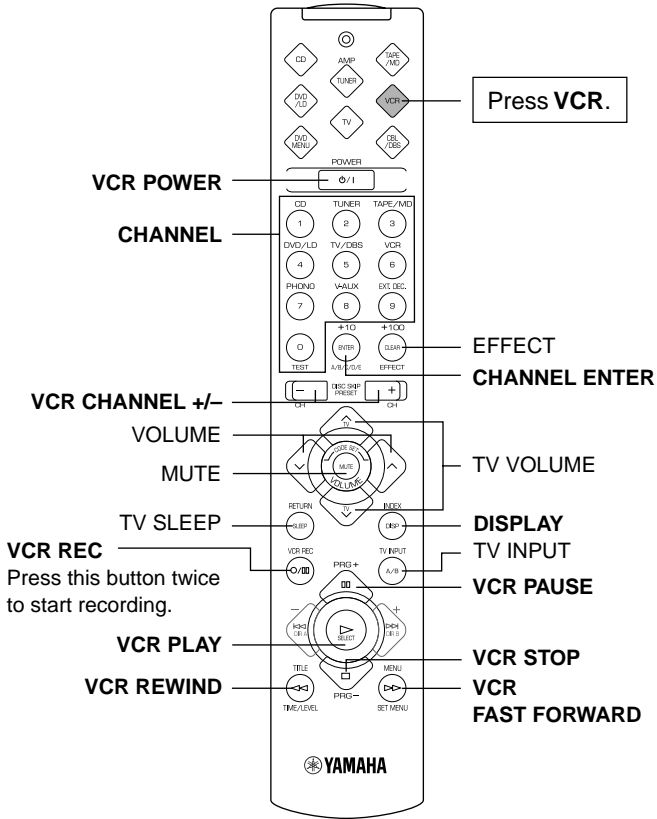

### TV MODE

**Note:** You can control your VCR if you have preset the code for it.

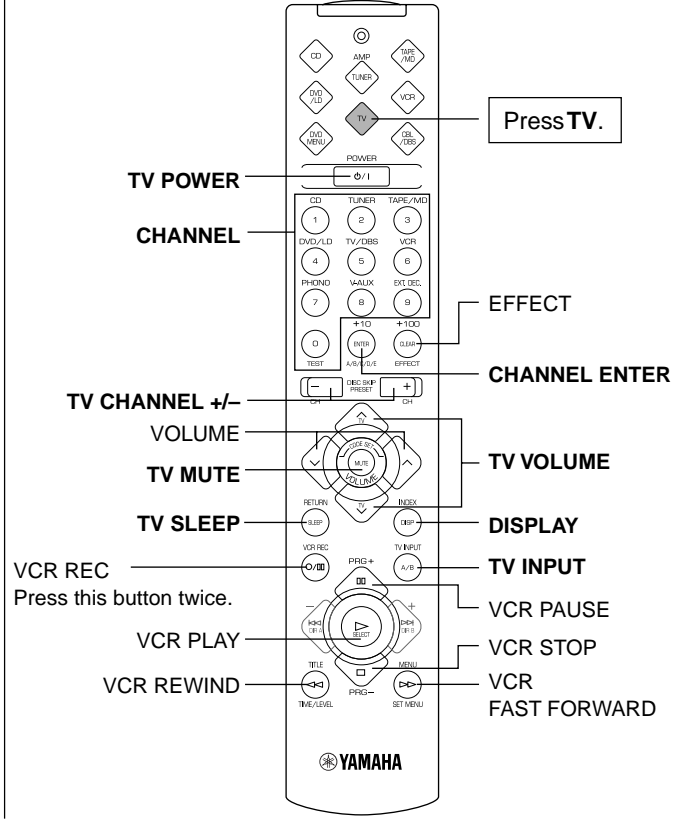

### CBL/DBS MODE

**Note:** TV VOLUME, TV INPUT and TV SLEEP function if you have preset the code for your TV.

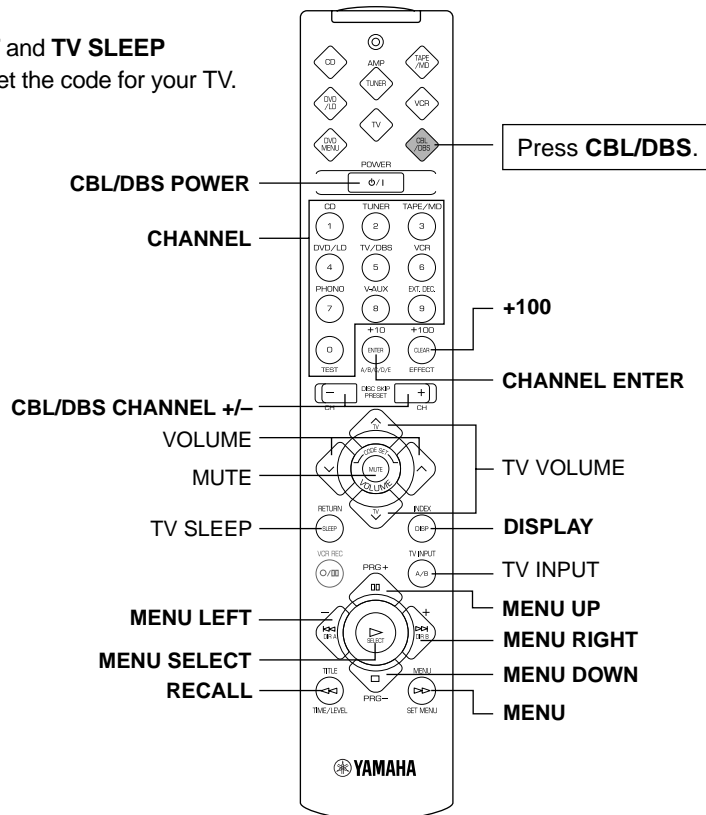

## NOTES ABOUT THE REMOTE CONTROL TRANSMITTER

### Battery installation

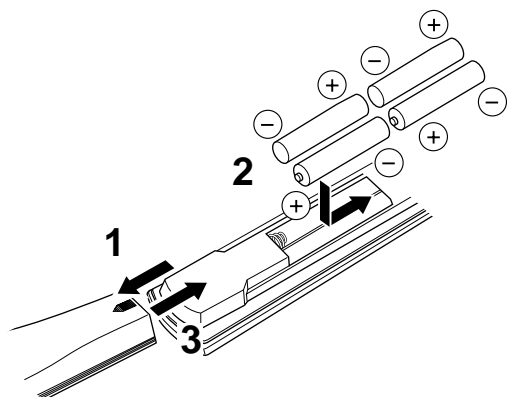

### Battery replacement

If the remote control transmitter operates only when it is close to the unit, the batteries are weak. Replace all batteries with new ones.

Be sure to replace batteries within about two minutes. If it takes longer than two minutes, the codes preset for the remote control transmitter will return to the factory-set.

#### Notes

- Use only AAA, R03, UM-4 batteries for replacement.
- Be sure the battery polarity is correct. (See the illustration inside the battery compartment.)
- Remove the batteries if the remote control transmitter will not be used for an extended period of time.
- If the batteries have leaked, dispose of them immediately. Avoid touching the leaked material or letting it come into contact with clothing, etc. Clean the battery compartment thoroughly before installing new batteries.

### Remote control transmitter operation range

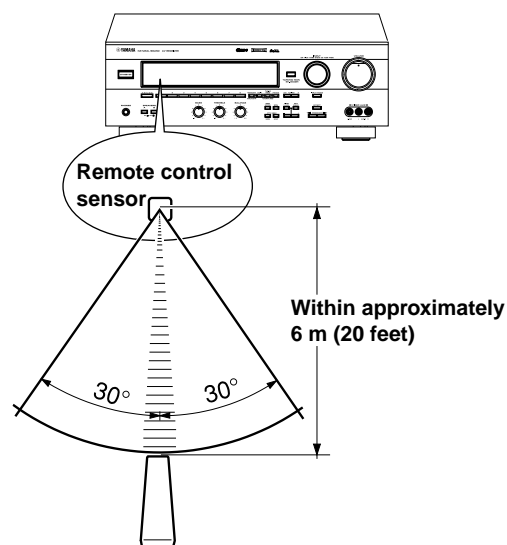

#### Notes

- There should be no large obstacles between the remote control transmitter and the unit.
- If the remote control sensor is directly illuminated by strong lighting (especially an inverter type of fluorescent lamp, etc.), it might cause the remote control transmitter not to work correctly. In this case, reposition the unit to avoid direct lighting.

# SETUP CODES

## Presetting the remote control transmitter

Perform the presetting procedure for each component you want to control with the remote control transmitter.

**Note:** If your component does not respond to any of the codes listed for the manufacturer, use the original remote control transmitter that was supplied with the component.

### To control your components (MD recorder, DVD player, TV, etc.)

1. Turn on the component to be used.
2. Press the component selector which matches the component to be controlled (TAPE/MD, DVD/LD, TV etc.).

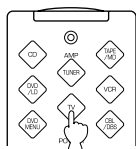

3. Press both **VOLUME** buttons ( ^ v ) for about four seconds at the same time so that the indicator flashes twice.

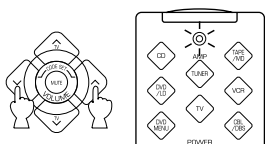

4. Use the numeric buttons to enter the four-digit manufacturer's code for the component to be used. Make sure that the indicator flashes twice. If the indicator does not flash, repeat step 3 and re-enter the code.

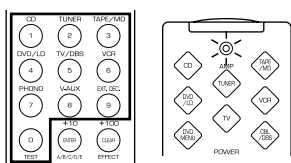

5. Press **POWER** (or any other button) on the remote control transmitter to check if you have preset the code correctly. If the component cannot be controlled by the remote control transmitter, try entering another code for the same manufacturer.

### To use a second (and third) VCR

You can control a second (and/or third) VCR in the CBL/DBS and DVD MENU modes if a CBL (or DBS) or DVD player is not being used.

If you want to control a second (and/or third) VCR in the DVD MENU mode, you must preset the code for an LD player in that mode.

1. Turn on the VCR to be used.
2. Press **CBL/DBS** or **DVD MENU** on the component selector.

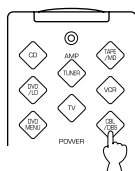

3. Press both **VOLUME** buttons ( ^ v ) for about four seconds at the same time so that the indicator flashes twice.

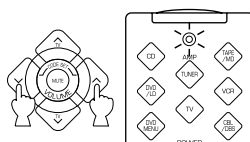

4. Use the numeric buttons to enter the four-digit code for the second (or third) VCR. Make sure that the indicator flashes twice. If the indicator does not flash, repeat step 3 and re-enter the code.

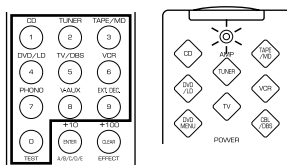

5. Press **POWER** (or any other button) on the remote control transmitter to check if you have preset the code correctly. If the VCR cannot be controlled by the remote control transmitter, try entering another code for the same manufacturer.

### Returning to the factory-set codes

To return all components to the factory-set codes, follow these steps.

1. Press a button on the component selector other than **AMP<TUNER>**.
2. Press both **VOLUME** buttons ( ^ v ) for about four seconds at the same time so that the indicator flashes twice.
3. Enter the code number "9990".
4. Make sure that the indicator flashes twice.

To return each component to the factory-set codes, follow these steps.

1. Press the component selector which matches the component to be returned to the factory-set codes.
2. Press both **VOLUME** buttons ( ^ v ) for about four seconds at the same time so that the indicator flashes twice.
3. Enter the code number "0000".
4. Make sure that the indicator flashes twice.

The following codes are preset by the factory.

#### Factory-set codes

Component selector	Component	Code
TV	TV	0101
CBL/DBS	DBS tuner	0006
VCR	VCR	0002
DVD/LD	DVD player	0008 YAMAHA
CD	CD player	0005 YAMAHA
TAPE/MD	Tape deck	0004 YAMAHA

We recommend that you write all code numbers you have preset on the "Quick Reference Card".



# TROUBLESHOOTING

If the unit fails to operate normally, check the following points to determine whether the fault can be corrected by the simple measures suggested. If it cannot be corrected, or if the fault is not listed in the SYMPTOM column, disconnect the power cord and contact your authorized YAMAHA dealer or service center for help.

	SYMPTOM	CAUSE	REMEDY
Amplifier	The unit fails to turn on when <b>STANDBY/ON</b> is pressed, or set in the standby mode suddenly soon after the power has been turned on.	The power cord is not plugged in or the plug is not completely inserted.	Firmly plug in the power cord.
		The <b>IMPEDANCE SELECTOR</b> switch on the rear panel is not fully set at the upper or lower end.	Slide the switch fully to the upper or lower end.
	The unit does not work normally.	The internal microcomputer has been frozen by an external electric shock (lightning, excessive static electricity, etc.) or by a power supply with low voltage.	Set the unit in the standby mode and disconnect the AC power cord from the AC outlet. After about 30 seconds have passed, connect the power cord and operate the unit again.
	No sound or no picture.	Incorrect output cord connections.	Connect the cords properly. If the problem persists, the cords may be defective.
		Appropriate program source has not been selected.	Select an appropriate program source by <b>INPUT</b> .
		<b>SPEAKERS</b> have not been set properly.	Set <b>SPEAKERS</b> corresponding to the speakers in use to the ON position.
		The speaker connections are not secure.	Secure the connections.
	The sound suddenly goes off.	The protection circuit has been activated because of a short circuit, etc.	Set the unit in the standby mode and then switch on again to reset the protection circuit.
		The SLEEP timer has functioned.	Cancel the SLEEP timer.
	Only one side speaker outputs sound.	Incorrect setting of <b>BALANCE</b> .	Adjust it to the appropriate position.
		Incorrect cord connections.	Connect the cords properly. If the problem persists, the cords may be defective.
	A "humming" sound can be heard.	Incorrect cord connections.	Firmly connect the audio plugs. If the problem persists, the cords may be defective.
		No connection from the turntable to the <b>GND</b> terminal.	Make the GND connection between the turntable and this unit.
	The volume level is low while playing a record.	The record is being played on a turntable with an MC cartridge.	The turntable should be connected to the unit through the MC head amplifier.
	The volume level cannot be increased, or the sound is distorted.	The component connected to the <b>REC OUT</b> terminals of this unit is in the standby mode.	Turn on the power to the component.
	No sound from the effect speakers.	The sound effect is set off.	Press <b>EFFECT</b> to turn it on.
		A Dolby Surround decoding program is being used with material not encoded with Dolby Surround.	Use a different sound field program.
	No sound from the rear speakers.	The sound output level of the rear speakers is set to minimum.	Raise the sound output level of the rear speakers.
		A monaural sound source is being played in the <b>DOLBY PRO LOGIC</b> or <b>DOLBY PRO LOGIC ENHANCED</b> program.	Select another sound field program suitable for the monaural sound source.

	SYMPTOM	CAUSE	REMEDY
Amplifier	<b>No sound from the center speaker.</b>	The input signals of the source encoded with Dolby Digital do not have center channel signals.	Refer to the instruction for the source being currently played.
		The sound output level of the center speaker is set to minimum.	Raise the sound output level of the center speaker.
		The function "CNTR" in the SET MENU is set to the NONE position.	Select the LARGE or SMALL position.
		Incorrect sound field program selection.	Select the appropriate program.
	<b>The sound field cannot be recorded.</b>	It is not possible to record the sound field on a tape deck or MD recorder connected to the unit's <b>REC OUT</b> terminals.	
	<b>The DVD/LD, TV or DBS source cannot be recorded on a tape deck, MD recorder or VCR connected to this unit.</b>	The DVD/LD player, TV or DBS tuner is connected to the unit by only the digital terminals.	Make additional connections between the analog terminals.
FM	<b>FM stereo reception is noisy.</b>	The characteristics of FM stereo broadcasts may cause this problem when the transmitter is too far away or the antenna input is poor.	Check the antenna connections. Try using a high-quality directional FM antenna. Set <b>TUNING MODE</b> to the manual tuning mode.
	<b>There is distortion and clear reception cannot be obtained even with a good FM antenna.</b>	There is multipath interference.	Adjust antenna position to eliminate multipath interference.
	<b>The desired station cannot be tuned in with the automatic tuning method.</b>	The station is too weak.	Use the manual tuning method. Use a high-quality directional FM antenna.
	<b>Previously preset stations can no longer be tuned in.</b>	This unit has been unplugged for a long period.	Repeat the presetting procedure.
AM	<b>The desired station cannot be tuned in with the automatic tuning method.</b>	The signal is weak or antenna connections are loose.	Tighten the AM loop antenna connections and rotate it for best reception. Use the manual tuning method.
	<b>There are continuous crackling and hissing noises.</b>	Noise will result from lightning, fluorescent lamps, motors, thermostats and other electrical equipment.	Use an outdoor antenna and a ground wire. This will help somewhat, but it is difficult to eliminate all noise.
	<b>There are buzzing and whining noises (especially in the evening).</b>	A television set is being used nearby.	Relocate this unit away from the TV.
Remote control transmitter	<b>The remote control transmitter does not work.</b>	Direct sunlight or lighting (from an inverter type of fluorescent lamp, etc.) is striking the remote control sensor of the this unit.	Change the position of the unit.
		The manufacturer's code has not been set properly.	Set the code again.
		The proper manufacturer's code for the component to be controlled has not been set.	Try entering another code for the same manufacturer.
		The component to be controlled has not been selected.	Press the component selector which matches the component to be controlled.

	SYMPTOM	CAUSE	REMEDY
Others	The sound is degraded when listening with the headphones to a CD player or tape deck that is connected to this unit.	The unit is in the standby mode.	Turn on the power to the unit.
	There is noise interference from digital or high-frequency equipment or the unit.	The unit is too close to the digital or high-frequency equipment.	Move the unit further away from those equipment.

## SPECIFICATIONS

### AUDIO SECTION

#### Minimum RMS Output Power

8 ohms, 20 Hz to 20 kHz, 0.04% THD	
MAIN L/R .....	60 W + 60 W
CENTER .....	60 W
REAR L/R .....	60 W + 60 W
8 ohms, 1 kHz, 0.07% THD	
MAIN L/R .....	70 W + 70 W
CENTER .....	70 W
REAR L/R .....	70 W + 70 W

#### Dynamic Power per Channel

(by IHF Dynamic Headroom measuring method)

MAIN L/R	
8/6/4/2 ohms .....	80/100/120/145 W

#### DIN Standard Output Power per Channel

[Europe model only]	
4 ohms, 1 kHz, 0.7% THD .....	100 W

#### IEC Power

[Europe model only]	
8 ohms, 1 kHz, 0.04% THD ....	65 W + 65 W

#### Power Band Width

8 ohms, 30 W, 0.1% THD ...	10 Hz to 50 kHz
----------------------------	-----------------

#### Damping Factor

MAIN L/R	
8 ohms, 20 Hz to 20 kHz .....	60 or more

#### Input Sensitivity/Impedance

PHONO MM .....	2.5 mV/47 k-ohms
CD/TAPE-MD/DVD-LD/TV-DBS/VCR/	
VIDEO AUX .....	150 mV/47 k-ohms
EXT. DECODER	
MAIN L/R .....	150 mV/47 k-ohms
CENTER/SURROUND L/R/SUBWOOFER	
.....	150 mV/40 k-ohms

#### Maximum Input Signal

PHONO MM	
1 kHz, 0.1% THD .....	100 mV or more
CD/TAPE-MD/DVD-LD/TV-DBS/VCR/	
VIDEO AUX (EFFECT ON)	
1 kHz, 0.5% THD .....	2.2 V or more

#### Output Level/Impedance

REC OUT .....	150 mV/1.2 k-ohms
SUBWOOFER	
(MAIN SP: SMALL) .....	4.0 V/1.2 k-ohms

#### Headphones Jack Rated Output/Impedance

CD/TAPE-MD/DVD-LD/TV-DBS/VCR/	
VIDEO AUX input,	
1 kHz, 150 mV, 8 ohms .....	0.4 V/390 ohms

#### Frequency Response (20 Hz to 20 kHz)

CD/TAPE-MD/DVD-LD/TV-DBS/VCR/	
VIDEO AUX to MAIN L/R SP OUT	
.....	0±0.5 dB

#### RIAA Equalization Deviation

PHONO MM .....	0±0.5 dB
----------------	----------

#### Total Harmonic Distortion (20 Hz to 20 kHz)

PHONO MM to REC OUT	
1 V .....	0.02% or less
CD/TAPE-MD/DVD-LD/TV-DBS/VCR/	
VIDEO AUX (EFFECT OFF) to MAIN SP OUT	
30 W/8 ohms .....	0.025% or less

#### Signal-to-Noise Ratio (IHF-A Network)

PHONO MM to REC OUT	
(5 mV, Input Shorted) .....	81 dB or more
CD/TAPE-MD/DVD-LD/TV-DBS/VCR/	
VIDEO AUX (EFFECT OFF) to MAIN SP	
OUT	
(150 mV, Input Shorted) .....	96 dB or more

#### Residual Noise (IHF-A Network)

MAIN L/R SP OUT .....	150 μV or less
-----------------------	----------------

#### Channel Separation

(Vol. -30 dB, EFFECT OFF)	
PHONO MM	
(Input Shorted, 1 kHz/10 kHz)	
.....	60 dB or more/55 dB or more
CD/TAPE-MD/DVD-LD/TV-DBS/VCR/	
VIDEO AUX	
(Input 5.1 k-ohms Terminated, 1 kHz/10 kHz)	
.....	60 dB or more/45 dB or more

#### Tone Control Characteristics

BASS: Boost/cut .....	±10 dB (50 Hz)
Turnover Frequency .....	350 Hz
TREBLE: Boost/cut .....	±10 dB (20 kHz)
Turnover Frequency .....	3.5 kHz

#### Filter Characteristics

MAIN L/R, REAR L/R (SPEAKER: SMALL)	
(H.P.F) .....	fc = 90 Hz, 12 dB/oct.
SUBWOOFER	
(L.P.F) .....	fc = 90 Hz, 18 dB/oct.

### VIDEO SECTION

Video Signal Type ..... PAL

Video Signal Level ..... 1 Vp-p/75 ohms

Maximum Input Level ..... 1.5 Vp-p or more

Signal-to-Noise Ratio ..... 50 dB or more

Monitor Out Frequency Response  
..... 5 Hz to 10 MHz, -3 dB

## FM SECTION

Tuning Range ..... 87.50 to 108.00 MHz

Usable Sensitivity (DIN)  
Mono (S/N 26 dB) ..... 0.9  $\mu$ V  
Stereo (S/N 46 dB) ..... 28  $\mu$ V

Selectivity  
(two signals, 40 kHz Dev.  $\pm$ 300 kHz)  
..... 55 dB

Signal-to-Noise Ratio  
(DIN-Weighted, 40 kHz Dev.)  
Mono/Stereo ..... 75 dB/69 dB

Harmonic Distortion (1 kHz)  
Mono/Stereo ..... 0.1%/0.2%

Stereo Separation (1 kHz) ..... 48 dB

Frequency Response  
20 Hz to 15 kHz ..... 0 $\pm$ 1 dB

Antenna Input ..... 75 ohms, Unbalanced

Output Level  
(40 kHz Dev., 1 kHz) ..... 550 mV

## AM SECTION

Tuning Range ..... 531 to 1,611 kHz

Usable Sensitivity ..... 300  $\mu$ V/m

Signal-to-Noise Ratio ..... 52 dB

Antenna ..... Loop antenna

Output Level  
(30% mod., 1 kHz) ..... 150 mV

## GENERAL

Power Supply ..... AC 230 V, 50 Hz

Power Consumption ..... 230 W

AC Outlets  
2 SWITCHED OUTLETS  
[Europe model] ..... 100 W max. total  
1 SWITCHED OUTLET  
[U.K. model] ..... 100 W max.

Dimensions (W x H x D)  
..... 435 x 151 x 391 mm  
(17-1/8" x 5-15/16" x 15-3/8")

Weight ..... 11.5 kg (25 lbs. 6 oz.)

Accessories ..... AM loop antenna  
Indoor FM antenna  
75-ohm/300-ohm antenna adapter  
(U.K. model only)  
Remote control transmitter  
Batteries

Specifications are subject to change without notice.

**LIST OF MANUFACTURER'S CODES  
LISTES DES CODES FABRICANT  
VERZEICHNIS DER HERSTELLERCODES  
LISTA ÖVER TILLVERKARKODER  
ELENCO DEI CODICI DEL FABBRICANTE  
LISTA DE CÓDIGOS DE FABRICANTES  
LIJST VAN CODES VAN FABRIKANT**

**TV**

Admiral	0411, 0451, 0911, 1021, 1081	Clarivox	0821, 0961, 1971	Fisher	0021, 0091, 0141, 0511, 0601, 0801, 0821, 0981, 1021, 1081, 1981, 2091
Aiko	0891	Clatronic	1181, 1331	Forgestone	2281
Akai	0061, 0101, 0231, 1191, 1351, 1591, 1641, 1791, 1891, 1981	Concerto	0791	Formenti	0451, 0491, 0761, 1081, 1451, 1541, 1981
Akura	1331	Condor	0761	Formenti-phoenix	0021, 0431, 0451, 0591, 1411
Alba	1241, 1331, 2361	Contec	0151, 1171	Fortress	1081
Albiral	1971	Continental Edison	0571, 0651, 0901	Frontech	0451, 1181, 1981
Amstrad	1301, 1511	Craig	1171	Fujitsu	1261
Anam	1171	Crosley	0021, 0491, 1021, 1081, 1401, 1981, 2201, 2251, 2271	Funai	0391, 0691, 1171, 1181, 1261
Arc En Ciel	0571	Crown	2541	Futuretech	1171
Arcam	0571, 0761	Ctc Clatronic	0261	GBC	0021, 0141, 1321, 1511, 1621, 1981
Aristona	0751	CXC	1171	GEC	0451, 1101, 1281, 2321
Arthur Martin	0451, 1641	Daewoo	0101, 1501, 1511, 2611	GEC (UK)	0031, 0081, 0581, 0601, 1101, 1281, 1561
ASA	0411, 0451, 0521, 0781, 0871, 1021, 1081, 1421, 2051, 2091, 2151, 2551	Dansai	0101	Geloso	0021, 0411, 0451, 1321, 1511, 1621, 1981
Astra	1511	Decca	0271, 0581, 0601, 0971, 1101, 1691	General Technic	2681
Atlantic	0761	Decca (UK)	0271, 0581, 0601, 1101, 1681	Genexxa	0451, 1331
Atlantic	0761	Degraaf	0451, 1351	GoldStar	0591, 0601, 0761, 0791, 1371, 1491, 1511, 1561, 1621, 1641
Atori	1511	Dixi	0991, 1511	Goodmans	0141, 1101, 1371, 1641, 2301
Audiosonic	1181, 1321, 1511	Domeos	0101	Gorenje	0981, 1061
Ausind	0491, 1411	Doric	1031	Graetz	0451
Autovox	0091, 0351, 0481, 0491, 0601, 0781, 0951, 1051, 1081, 1391, 1421	Dual	0091, 0601, 1611, 1641, 2101	Granada	0141, 0451, 0491, 0581, 0601, 1101, 1111, 1351, 1981, 2321
Baird	1101, 1351	Dual-Tec	0601, 1511, 1621, 2111	Granada (UK)	0081, 0141, 0451, 0491, 0581, 0601, 1031, 1311, 1521, 1561, 1641
Bang & Olufsen	1081	Dumont	0261, 0521, 0781, 1021, 1081, 1981, 2121, 2151	Grundig	0221, 0231, 0471, 0491, 0711, 0741, 1381, 2021, 2041, 2141, 2151
Basic Line	1321, 1331	Dynatron	0101	Hanseatic	0021, 0121, 0141, 0431, 0591, 1561
Bauer	1451	Elbe	1551, 1971, 2031	Hantarex	0581
Baur	0041, 0061, 0121, 0131, 0221, 1561	Electro Tech	1511	Hemmermann	0061
Beko	2491, 2501	Elektroniska	0771	Hifivox	0331, 0571
Blaupunkt	0221, 0231, 0241, 0251, 0471, 0741, 2201, 2211, 2221, 2231, 2241, 2261, 2571, 2581	Elman	0261, 1621	Hinari	0071, 0141, 0451, 1261, 1351, 1511, 1641, 1981, 2011
Brandt	0571, 0651, 0731, 0901, 1821	Elta	1511	Hitachi	0001, 0011, 0031, 0081, 0141, 0291, 0331, 0341, 0451, 0601, 0631, 0701, 1281, 1561, 1601, 1821, 1831, 1841, 1861, 1871, 1881, 1891, 1941, 1981, 2051, 2321, 2341
Brionvega	1021, 1051, 1081	Emerson	0921, 1021, 1081, 1121, 1171, 1261, 1301		
Britannia	0761	Erres	0101		
Bruns	0821, 0991, 1021, 1081	Etron	1981		
BSR	0391, 0691, 1621, 1901, 1981	Europhon	0261, 0581, 0601, 0771, 1091, 1621, 2001		
Bush	0451, 1241, 1331, 1641, 1741, 2131, 2151	Fenner	0101, 1511		
Bush (UK)	0481, 1561, 1611	Ferguson	0281, 0371, 0551, 0651, 0781, 0861, 0881, 1131, 1181, 1361, 1461, 1971, 1991, 2281, 2311, 2341		
Candle	0791	Fidelity	0451, 0761, 2281		
Century	1021, 1081	Fidelity (UK)	0561, 0591, 1931, 2281		
CGE	0491, 0811, 0981, 1401, 1531, 1611, 1621, 1981, 2201, 2251, 2271	Filmnet	1141		
Citizen	0791	Finlandia	0451, 2321		
		Finlux	0021, 0261, 0491, 0521, 0781, 0811, 0871, 1081, 1411, 1421, 1981, 2051, 2091, 2121, 2151, 2551		
		First Line	1981		

Hyper	0591, 0601, 1511, 1621	Magnafon	0261, 0491, 0581, 0591, 0641, 0761, 1091, 2001	Orion	0061, 0391, 0691, 0851, 1211, 1241, 1251, 1301, 1481, 1511, 1681, 1691, 1981, 2371, 2421
Imperial	0451, 0491, 0811, 0981, 1401, 1611, 1621, 2201, 2251, 2271	Manesth	0101	Osaka	2011
Ingersol	1511	Marantz	0101	Osaki	1101, 1331, 2011
Inno Hit	0581, 0601, 0841, 1101, 1331, 1371, 1511, 2011	Marelli	1081	Osume	0151
Innovation	2591, 2601, 2611, 2621, 2641, 2651, 2661, 2711, 2721, 2761, 2771, 2781	Mark	0101	Otto Versand	0021, 0121, 0141, 0221, 0601, 1561, 1741, 1981
Interfunk	0031, 0041, 0061, 0121, 0181, 0451, 0491, 1081, 1641, 1791, 1821, 1981, 2231	Matsui	0061, 0451, 0601, 0691, 1101, 1151, 1241, 1271, 1301, 1511, 1561, 1681, 1691	Pael	0591, 1411
Irradio	0491, 1321, 1331, 1371, 1411, 1511, 2011	Maximal	0071, 1981	Panasonic	0031, 0201, 0211, 0451, 0701, 1311, 1751, 1961, 2561, 2741
Isukai	1331	McMichael	1281	Panoramic	2351
ITT	0031, 0041, 0051, 0061, 0071, 0081, 0181, 0411, 0451, 0491, 1241, 1291, 1351, 1501, 1601, 1641, 1741, 1921, 1981, 2091, 2331, 2431	Medion	2591, 2601, 2611, 2621, 2641, 2651, 2661, 2671, 2681, 2691, 2711, 2721, 2761, 2771, 2781	Pathe Marconi	0571
ITT-nokia	0031, 0041, 0051, 0061, 0071, 0081, 0181, 0411, 0451, 0491, 1241, 1291, 1351, 1501, 1601, 1641, 1741, 1921, 1981, 2091, 2331, 2431	Memorex	1511	Pathe' Cinema (F)	0431, 0591, 1621, 1661, 1971
JVC	0071, 0721, 1441, 1581, 1591, 1741, 1791	Metz	0231, 0741, 1001, 1041, 1081, 1481, 2071, 2081	Pausa	1511
Kaisui	0591, 1321, 1331	MGA	1231	Pauza	1511
Kamosonic	0601	Micromaxx	2591, 2621, 2641, 2651, 2711, 2761, 2771, 2781	Perdio	0891, 1101
Karcher	0591, 0601, 0841, 1091, 1321, 1511, 1561, 2051	Minerva	0221, 0231, 0491, 1381, 2141, 2151	Philco	0021, 0491, 0811, 0981, 1021, 1081, 1401, 1611, 1621, 1751, 2201, 2251, 2271, 2451, 2471
Kawasho	0761	Mistral	2281	Philips	0101, 0361, 0591, 0621, 0681, 0751, 0761, 1021, 1081, 1281, 2031, 2281, 2291, 2431, 2441, 2511, 2731
Kendo	0261	Mitsubishi	0141, 0201, 0231, 0661, 1191, 1201, 1231, 1671, 1691, 1741	Phoenix	1081
Kennedy	0021, 0351, 0951, 1981	Mivar	0491, 0501, 0581, 0591, 0761, 0771, 1371, 1431, 2031	Phonola	0751, 1081
Konka	2701	MTC	0791	Pioneer	0291, 0451, 1341, 1821
Korting	0431, 1011, 1021, 1081, 1541	Multitech	0261, 0581, 0601, 0641, 0981, 1321, 1511	Prandoni-prince	0411, 0451, 0491, 0581, 1411
KTV	0601, 1171	Murphy	0451, 2091	Prandoni-promce	0451, 0491, 0581
Lenoir	0601, 1511	Murphy (UK)	0081, 1031	Prima	0451
Leyeo	1181	N.E.I.	0101, 0961	Profex	1981
Lifetec	2591, 2601, 2611, 2621, 2641, 2651, 2661, 2671, 2681, 2691, 2711, 2761, 2771, 2781	NAD	1341	Protech	0641, 1181, 1981
Loewe Opta	0121, 0131, 0581, 0611, 1081	NEC	0141, 1711, 1721, 1731	Quelle	0041, 0061, 0121, 0221, 0231, 0391, 0491, 0521, 0601, 0781, 1371, 1381, 1411, 1421, 1641, 1681, 2051, 2091, 2141, 2151, 2201, 2211, 2231, 2241, 2251, 2271, 2551, 2571, 2581
Logic	1691, 2281	Neckermann	0451, 0601, 0981, 1081, 1561, 1931, 1981, 2211, 2231, 2241	Radiomarelli	0101, 0451, 0661, 0771, 1081
Logik	0551, 1681, 2281	Nediator	0101	Radionette	0031, 2051, 2091
Lowewe	0831	Nicamagic	0761	Radiola	2291
Luma	0351, 0451, 1901	Nikkai	1101, 1331, 1641, 1701, 2011	Rank	0481, 2151
Luxman	0791	Nobluko	0261, 0491, 0591, 0641, 1381, 1411	Rbm	2131, 2151
Luxman Stereo Tuner	0791	Nogamatic	0571	Rbm (UK)	0481
Luxor	0001, 0061, 0181, 0341, 0421, 0451, 0461, 0491, 0601, 0671, 1351, 1371, 1561, 1601, 1911, 1921, 1981	Nokia	0031, 0041, 0051, 0061, 0071, 0081, 0181, 0411, 0451, 0491, 1241, 1291, 1351, 1501, 1601, 1641, 1741, 1921, 1981, 2091, 2331, 2431, 2461, 2791	Rediffusion	0451, 0661, 1641, 1981, 2331
Lycy	1181	Nordmende	0031, 0291, 0331, 0451, 0531, 0541, 0571, 1051, 1131, 1591, 1791, 1811, 1821, 1891, 1941, 2631	Rediffusion (UK)	0061, 0081, 1031
Magnadyne	0021, 0061, 0261, 0581, 0641, 0771, 1021, 1081, 1621, 1981	Oceanic	0321, 1651, 1981	Rex	0071, 0101, 0351, 0411, 0451, 0951, 1901, 2061, 2101, 2111
		Oceanic (F)	0031, 0061, 0321, 0441, 1661	Rft	0991, 2511
		Onceas	0601	Roadstar	1321, 1511
		Onwa	1171	Rotel	0151
				Saba	0291, 0331, 0421, 0451, 0531, 0541, 0571, 0581, 0651, 0731, 0931, 1021, 1071, 1081, 1131, 1791, 1811, 1821, 1891, 1941, 2631

Saccc 1971  
 Saisho 0451, 0601, 1161, 1241, 1301, 1511, 1671, 1681, 1691  
 Salora 0011, 0041, 0061, 0071, 0341, 0451, 0671, 1291, 1351, 1521, 1561, 1601, 1641, 1911, 1921, 1931, 1981, 2321  
 Sambers 0261, 0491, 0581, 0641, 1091, 1371, 1411, 2001  
 Samsung 0101, 0601, 0841, 0981, 1101, 1181, 1371, 1511, 2011  
 Sanyo 0141, 0151, 0401, 0601, 0801, 0821, 0981, 1021, 1101, 1111, 1291, 1351, 1691, 1741, 2051, 2091, 2551  
 SBR 0681, 0751, 1281, 2281  
 Schaub Lorenz 0451  
 Schneider 0021, 0071, 0091, 0451, 0511, 0591, 0601, 0751, 1321, 1361, 1621, 1641, 2101, 2111, 2291  
 Scott 1171, 1261  
 SEG 0261, 0601, 0821, 0991  
 SEI 0641, 0691, 1081, 1301, 1481, 1981  
 Seleco 0071, 0101, 0351, 0411, 0451, 0951, 1901, 2061, 2101, 2111  
 Sentra 1601  
 Sharp 0141, 0151, 0191, 1761, 1781  
 Siarem 0021, 0261, 0581, 0641, 1021, 1081, 1981  
 Sicatel 1971  
 Siemens 0151, 0221, 0231, 0451, 0741, 2011, 2201, 2211, 2221, 2231, 2241, 2261, 2571, 2581  
 Silver 1181  
 Singer 0021, 0261, 1021, 1081  
 Sinudyne 0101, 0021, 0061, 0261, 0391, 0641, 0691, 0851, 0941, 1021, 1081, 1241, 1301, 1321, 1481, 1631, 1981  
 Skantic 0451  
 Solavox 0451, 1641, 2011  
 Sonoko 1181, 1511, 0101  
 Sony 0141, 0171, 1121, 1681, 1691, 2751  
 Soundesign 1171  
 SSS 1171  
 Stern 0071, 0101, 0351, 0411, 0451, 0951, 1901, 2061, 2101, 2111  
 Sunkai 0691  
 Supra 0791  
 Tandberg 0161, 0331, 0611, 1021, 1421, 1771, 1791, 2081  
 Tandy 0451, 0191, 1331, 1531

Tashiko 0141  
 Tatung 0271, 0581, 0601, 0971, 1101, 1681, 1691  
 Tcm 2621, 2641, 2711, 2761, 2771, 2781  
 Technics 1311  
 Techwood 0791  
 Teknika 1171, 1231, 1261  
 Tele 1141  
 Teleavia 0571, 0651, 0731, 1821  
 Telefunken 0291, 0301, 0311, 0551, 0731, 1131, 1471, 1591, 1791, 1801, 1811, 1821, 1991, 2161, 2171, 2181, 2191, 2201, 2251, 2271, 2521, 2631  
 Teletech 1511  
 Tempest 2381, 2391, 2401, 2411  
 Tensai 1331, 2091  
 Texet 0601  
 Thomson 0331, 0481, 0531, 0571, 0631, 0651, 0731, 0901, 1241, 1571, 1591, 1791, 1811, 1821, 1891, 1941, 2531  
 Thorn 0741, 0861, 2091, 2251, 2271, 2281  
 Thorn-Ferguson 0281, 0371, 0551, 0651, 0781, 0861, 0881, 1131, 1181, 1361, 1461, 1971, 1991, 2281  
 TMK 0141, 0791, 1471  
 Toshiba 0141, 0381, 0481, 1221, 1271, 1701, 1741, 1851, 2151, 2801, 2811  
 Trans Continens 0451  
 Tristar 2281  
 Triumph 0481, 0581, 2121  
 Uher 0431, 0451, 0481, 0491, 0511, 1311, 1541  
 Ultravox 0021, 0261, 0591, 1021, 1081, 1981  
 Universum 1181, 2051  
 Univox 1971  
 Vegavox 0811  
 Vexa 0101, 1511  
 Victor 1441, 1591  
 Videoton 2481  
 Vortec 0101, 0651  
 Voxson 0411, 0451, 0491, 1021, 1081  
 Waltham 0451  
 Watson 0431, 2201, 2241  
 Watt Radio 0021, 0061, 0261, 0591, 0641, 0761, 1091, 1971, 1981, 2001  
 Wega 0141, 1081, 1981  
 Wega Color 1021  
 Weltblick 0101  
 Weston 1621

White Westinghouse 0101, 0261, 0431, 0591, 0761, 1401, 1541  
 Yoko 0601, 1511  
 Zanussi 0071, 0101, 0351, 0411, 0451, 0951, 1901, 2061, 2101, 2111  
 Zoppas 0451

## CABLE

Cabletime 1446, 1456, 1476  
 Clyde Cablevision 1426  
 Filmnet 1396, 1436  
 France Telecom 1386  
 GEC 1426  
 Jerrold 1416  
 Movie Time 1466  
 NSC 1466  
 Philips 1386  
 Pioneer 0006  
 Samsung 1496  
 Scientific Atlanta 1486, 1506  
 Starcom 1416  
 STS 1466  
 Tele 1436  
 Tele+1 1436  
 Teleservice 1406, 1476  
 Tudi 1376  
 United Cable 1416  
 Zenith 1406

## DBS TUNER

Akai 1276  
 Alba 0826, 1276  
 Amstrad 0166, 0796, 1016, 1026, 1296  
 Ankaro 0476  
 Ast 0406  
 Astra 0126  
 Barcom 0476  
 Blaupunkt 0966  
 Bmc Satellite 0106  
 British Telecom 1276  
 Bush 0826  
 Bush (UK) 0956  
 Cambridge 0196, 1276  
 Chaparral 0016, 0696, 1006  
 Columbus 0616  
 Connexions 0306, 0426  
 Discus Elipse 0856, 0866  
 Diskxpress 0426, 0476  
 Drake 1516  
 Echostar 0226, 0236, 0606, 0626, 0666, 0926, 0996, 1046, 1056, 1066, 1106  
 Elta 1286  
 Elta Sat 0146

Eurodec	1226, 1236, 1246	Salora	0066, 0126, 0136, 0446,	Bush (UK)	0812
Ferguson	0046, 0176, 0186, 0296,		0456, 0486, 0496, 0576	Capehart	0112
	0846, 0956, 1306	Samsung	0746, 0756	CGE	0042, 0432, 0762
Finlux	0976	Sat	0406	Craig	0072, 0482
Fracarro	0026, 0536, 0776	Satcom	0896	Crown	0112, 0282, 0622
Fuba	0476, 0616, 0636, 1056	Sateco	0646	Daewoo	0112, 0282, 0622
Giucar Record	0206, 0336	Sector	1266	Dansai	0012
Grundig	0176, 0946, 0956, 0966	Sedea	1096	Daytron	0112
High Performance	0916	Sentra	0416	Decca	0042, 0052, 0432, 0942
Hirschmann	0756, 0966	Siemens	0896, 0966	Decca (UK)	0052
Hitachi	0446, 0516, 0706, 0946	Sintrack	0906	Degraaf	0052, 0132, 0432,
Icx International	0886	Skylab	0476		0532, 0602
ITT	0066, 0126, 0176, 0446, 1156	Skyscan	0876	Dixi	0442
ITT/Nokia	0066, 0126, 0176, 0446, 1156	Sony	0736, 0946	Dual	0042, 0632
Jeemon	0146	Stella	0306	Dumont	0052, 0432, 0532
Jerrold	0846, 0986	Strong	0156, 0396, 1036, 1086	Dynatech	0432
Johansson	0246	Stv	0636	Dynatron	0012
JVC	1276	Tandberg	1116, 1366	Elbe	0122
Kathrein	0116, 0266, 0276, 0366	Tandy	0916	Elin	0072
Kosmos	0266	Tantec	0616	Emerson	0012, 0162, 0202,
Kyostar	1036, 1086	Tatung	0516, 0546		0432, 0512, 0522
Leng	0246	Technisat	0086, 0096, 0526,	Erres	0012
Lifesat	1326, 1346, 1356		0556, 1056	Ferguson	0042, 0712, 0722, 0852,
Luxor	0126, 0136, 0446,	Telecom	0306		0902, 1012, 1022, 1082
	0466, 0506, 1156	Telex	0586	Fidelity	0432
Macab	0356	Thorn-Ferguson	0046, 0076, 0176,	Finlandia	0052, 0532
Maspro	0016, 0116, 0256, 0956		0186, 0956	Finlux	0012, 0042, 0052, 0082, 0262,
Medion	1326, 1346	Toshiba	0946		0382, 0432, 0462, 0492,
Metz	0966	Triad	0406		0532, 0572, 0602, 0912
Micromaxx	1326, 1346	Uniden	0036, 0216, 0676, 0716, 0726	First Line	0002, 0912
Mitsubishi	0966	US Electronics	0886	Fisher	0162, 0482, 0532,
Morgans	0596	Vortec	0756, 1036, 1076		0542, 0572, 0592
Muratto	0406	Vtech	0436	Formenti-Phoenix	0012, 0052
NEC	0286, 0316, 0766, 0786, 0836	Winersat	0246	Frontech	0112
Network	0046	Wisi	0056, 0356, 0376, 0386, 0406,	Funai	0432
Nikko	1136, 1146		0656, 1056, 1156	GBC	0002
Nokia	0066, 0126, 0176, 0446,	Wolsey	0916	GEC (UK)	0022, 0052
	1156, 1166, 1336	Zehnder	0266, 0406	Geloso	0002
Norsat	0786	Zender	0406	General Technic	1172
Otto Versand	0966			GoldStar	0012, 0122, 0812, 0952
Pace	0046, 0176, 0296,	<b>VCR</b>		Goodmans	0002, 0072, 0282,
	0936, 0956, 1306				0432, 0502
Pace Mss	0946	Aiwa	0042, 0352, 0432	Goodmans (UK)	0002
Palcom	0616, 0686, 0706	Akai	0042, 0422, 0492, 0582, 0612,	Graetz	0022, 0042
Palsat	0396		0642, 0652, 0762, 0912	Granada	0052, 0132, 0532, 0572
Paltec	0706	Alba	0002, 0112, 0282,	Granada (UK)	0052, 0092, 0462,
Panasonic	0806, 1306		0332, 0342, 0972		0602, 0812, 0822
Pansat	1076	Amstrad	0322, 0432, 0452	Grundig	0052, 0062, 0092, 0232,
Philips	0326, 0346, 0476, 0956,	Anitech	0002		0252, 0262, 0752, 0802
	1126, 1186, 1196, 1206,	Anitsch	1002	Hanseatic	0052, 0812
	1216, 1306, 1316	ASA	0012, 0052	Harman/Kardon	0122, 0922
Prosat	1176	Audiosonic	0002	Hcm	0002
Ptt Telecom	0306, 0896	Baird	0042, 0282, 0492	Hinari	0002, 0202, 0412, 0442, 0522
Quelle	0966	Bang & Olufsen	0042	Hitachi	0042, 0172, 0292, 0432,
Radix	1056	Baur	0052, 0062, 0812		0602, 0662, 0812, 1022
Rediffusion	0316, 0786	Blaupunkt	0062, 0092, 0252,	Imperial	0072, 0432
Rft	1186, 1196, 1206, 1216		0462, 0672, 0992	Ingersol	0442
Sagem	1256	Brionvega	0032	Inno Hit	0002, 0052, 0072
Sakura	0566, 0816	Bush	0002, 0282, 0332,	Innovation	1142, 1162, 1172
			0342, 0512, 0972	Interfunk	0022, 0052



Irradio	0002, 0012	Osaka	0432	TCM	1142, 1162, 1172
ITT	0022, 0032, 0042, 0072, 0292, 0492, 0532, 0572, 0762	Osaki	0002, 0012, 0432	Teac	0042, 0432
ITT-Nokia	0022, 0032, 0042, 0072, 0292, 0492, 0532, 0572, 0762	Otto Versand	0052, 0062, 0812	Technics	0462
Jensen	0042	Panasonic	0022, 0212, 0462, 0672, 0992, 1092, 1102, 1182	Teknika	0012, 0432
JVC	0042, 0102, 0142, 0272, 0742, 0762, 0782, 0902	Pentax	0172, 0602	Telefunken	0042, 0192, 0632, 0732, 0742, 0762, 0782, 0882, 0892
Karcher	0052, 0072, 0812	Perdio	0432	Tempest	1032, 1042, 1052
Kendo	0492	Philco	1062	Tenosal	0002
Kenwood	0042, 0142, 0572	Philips	0052, 0082, 0092, 0152, 0182, 0362, 0372, 0382, 0472, 0502, 1072	Thomson	0042, 0102, 0142, 0192, 0402, 0632, 0762
Lifetec	1142, 1162, 1172	Phonola	0052, 0152	Thorn	0042, 0902
Lloyd	0432	Pilot	0012	Thorn-Ferguson	0042, 0222, 0302, 0712, 0722, 0742, 0762, 0852, 0862, 0872, 0902
Loewe Opta	0052, 0092, 0152	Pioneer	0052, 0142, 0372, 0472	TMK	0522
Logik	0002, 0072, 0442	Portland	0112	Tonsai	0002
Luma	0162	Proline	0432	Toshiba	0042, 0622, 0912, 1212
Luxor	0492, 0572, 0812	Pye	0052, 0152	Totevision	0012, 0072
M Electronic	0432	Quartz	0572	Triumph	0922
Magnadyne	0052	Quelle	0012, 0032, 0042, 0052, 0062, 0072, 0092, 0202, 0462, 0552, 0942	Uher	0042, 0072
Magnasonic	0572	Radionette	0022	Ultravox	0032
Manesth	0012	Realistic	0012, 0072, 0132, 0432, 0482, 0502, 0532, 0572	Unitech	0072
Marantz	0012, 0052, 0092, 0122, 0502	Ret	1072	Vector Research	0122
Mark	0012	Rex	0042, 0742, 0782	Victor	0042, 0102, 0142
Marta	0012	Ricoh	0952	Videon	1162, 1172
Matsui	0012, 0442, 0512, 0522, 0812, 0972	Saba	0042, 0142, 0192, 0222, 0242, 0392, 0632, 0732, 0742, 0762, 0772, 0782, 0792, 0822	Weltblick	0012
Medion	1142, 1162, 1172	Saisho	0162, 0202, 0292, 0442, 0512, 0522, 0972	White Westinghouse	0032
Memorex	0012, 0132, 0432, 0482, 0532, 0572	Salora	0192, 0572, 0812, 0822, 0912	Xenon	0162
Metz	0062, 0092, 0932	Samsung	0052, 0072, 0622, 0652, 1192	Yoko	0012, 0062, 0072
MGA	0912	Sansui	0042, 0142		
Micromaxx	1142, 1162, 1172	Sanyo	0482, 0532, 0562, 0572	<b>DVD PLAYER</b>	
Minerva	0062, 0092, 0252	SBR	0052, 0152, 0182	Akai	0108
Minolta	0172, 0602	Schaub Lorenz	0022, 0042	JVC	0168
Mitsubishi	0052, 0062, 0142, 0912, 0922	Schneider	0002, 0012, 0052, 0072, 0432	Onkyo	0128
MTC	0072, 0432	SEG	0002, 0072	Panasonic	0048
Multitech	0002, 0052, 0062, 0282, 0432	Sei-Sinudyne	0442	Philips	0188
Murphy	0432	Seleco	0042	Pioneer	0208, 0228
N.E.I.	0012, 0052	Sentra	0112	Samsung	0148
National	0462	Sharp	0132, 0502, 0702	Sharp	0068
NEC	0042, 0122, 0142, 1202	Shintom	0002	Sony	0028
Neckermann	0032, 0042, 0052, 0072, 0092, 0202, 0522, 0572, 0762, 0812	Siemens	0062, 0092, 0252, 0572	Toshiba	0088
Nikkai	0112	Sinudyne	0052, 0382, 0442, 0932	Yamaha	0008, 0048
Nobliko	0092	Sonoko	0282		
Nokia	0022, 0032, 0042, 0072, 0292, 0492, 0532, 0572, 0762, 1152	Sony	0432, 0552, 0682, 0692, 0942, 0952, 0962, 1122, 1132	<b>LD PLAYER</b>	
Nordmende	0042, 0102, 0142, 0192, 0222, 0242, 0392, 0402, 0632, 0732, 0742, 0762, 0782, 0792, 0832, 0842, 0872	STS	0602	Aiwa	0137
Olympus	0462	Sunkai	0512	Funai	0137
Optonica	0132, 0502	Sunstar	0432	Hitachi	0047
Orion	0162, 0202, 0312, 0442, 0512, 0522, 0982	Sylvania	0432, 0912	Magnavox	0077
		Symphonic	0432, 0912	Panasonic	0027
		Tandberg	0062, 0162, 0522, 0932	Pioneer	0037
		Tashiko	0132, 0432	RCA	0067
		Tatung	0042, 0052, 0432, 0922	Realistic	0137
				Samsung	0017, 0087
				Sony	0057, 0097, 0107, 0117
				Victor	0127
				Yamaha	0007

---

## CD PLAYER

Accuphase 0315  
Adc 0865  
Adcom 0785, 1015  
Akai 0115, 0125, 0725, 0735,  
0745, 0935, 1155  
Arcam 1875  
Arcam-Rotel 0165  
Audio-Technica 0835  
Audiosonic 0155  
Awia 1105, 1235, 1245,  
1765, 1915, 1935  
BSR 0875  
California Audio Lab 1075  
Carrera 0555, 0875  
Carver 0825, 1415  
Cyrus-Rotel 0205  
Denon 0045, 0955, 1045,  
1595, 1795, 1805  
Dual 1005  
Elin 0185  
Emerson 1015, 1285, 1675  
Fisher 0105, 0595, 0605,  
0825, 1165, 1175  
Genexxa 0525, 0825, 0855, 0875,  
0995, 1265, 1285, 1345,  
1355, 1485, 1575, 1675,  
1715, 1825  
GoldStar 0555, 1185, 1195, 1585  
Grundig 0175  
Harman Kardon 0495, 0565, 0325,  
1135, 1145, 1155  
Hitachi 0065, 0585, 0685, 0945,  
1005, 1015, 1225, 1545  
Innovation 1995, 2005, 2015  
ITT-Nokia 0185  
JVC 0385, 0395, 0455, 0575, 0585  
Karcher 0485  
Kenwood 0025, 0055, 0145, 0215,  
0595, 0675, 0695, 0705,  
0715, 0925, 1355, 1485,  
1575, 1675, 1715, 1825  
Korting 0175  
Lifetec 2015

Light Control 1155, 1645, 1655, 1665  
Linn 0165, 1875  
Luxman 0265, 0275, 0795, 0805,  
1295, 1305, 1555, 1925  
Luxor 0185, 1895, 1905  
Magnavox 1865, 1875  
Marantz 0165, 0175, 0545, 0665,  
1275, 1335, 1405, 1505,  
1875, 1955  
Matsushita 1095, 1605  
MCS 0535  
Medion 0075, 1995, 2005, 2015  
Memorex 0525, 1015, 1265, 1275,  
1285, 1675  
MGA 1125  
Micromaxx 2015  
Mission 0165, 1875  
Mitsubishi 1125, 1205  
NAD 0255, 0285, 0295, 0305, 0345,  
0135, 0755, 0765, 1315, 1325  
Nakamichi 0635, 0645, 1565  
NEC 0405, 0535, 0775, 0785  
Neckerman 0155, 0225  
Nikko 0835, 1165  
Oceanic 0185  
Okano 0155, 0225  
Onkyo 0885, 1385, 1425, 1455, 1515  
Panasonic 1055, 1075, 1615, 1625  
Philips 0165, 0175, 0195, 1865, 1875  
Pioneer 0095, 0335, 0425, 0435, 0445,  
0525, 0855, 1035, 1945  
Proton 0905, 1875  
Quasar 1075  
Radiola 1845, 1855  
Radiotone 0485  
Realistic 0825, 1015, 1265,  
1275, 1285, 1575  
Rotel 1875  
Saba 1005  
SAE 1875  
Salora 0185  
Sansui 0415, 0965, 0975, 0985,  
1255, 1675, 1875  
Sanyo 0625, 0825, 0845, 0915  
Schneider 1845, 1855

Scott 1285, 1675  
Sharp 0025, 0035, 1025, 1115, 1275,  
1635, 1785, 1815, 1825, 1835  
Sherwood 1275, 1445  
Siemens 1085  
Signature 1155  
Sony 0345, 0355, 0365, 0375, 0865,  
1685, 1695, 1705, 1715, 1725,  
1735, 1745  
Sytvania 1875  
Tandberg 1885  
Tashiko 1525  
TCM 1985, 2015  
Teac 0235, 0245, 1275, 1365, 1375,  
1395, 1435, 1465, 1475  
Technics 0465, 0475, 1065, 1075, 1625  
Telefunken 1005  
Theta Digital 1865  
Thomson 1005  
Toshiba 0755, 0765  
Vector Research 0555, 0865  
Victor 0575  
Yamaha 0005, 0015, 0895, 1815

---

## MD RECORDER

Yamaha 0024

---

## TAPE DECK

Akai 0124  
Denon 0204  
Grundig 0134  
Harman 0044  
JVC 0194  
Kenwood 0164  
Korting 0134  
Luxman 0054, 0064, 0074, 0084  
Marantz 0134, 0144  
NAD 0174  
Onkyo 0184  
Philips 0134, 0144, 0154  
Pioneer 0034, 0114  
Sony 0094, 0104  
Yamaha 0004, 0014



# Quick Reference Card

## AMP<TUNER>

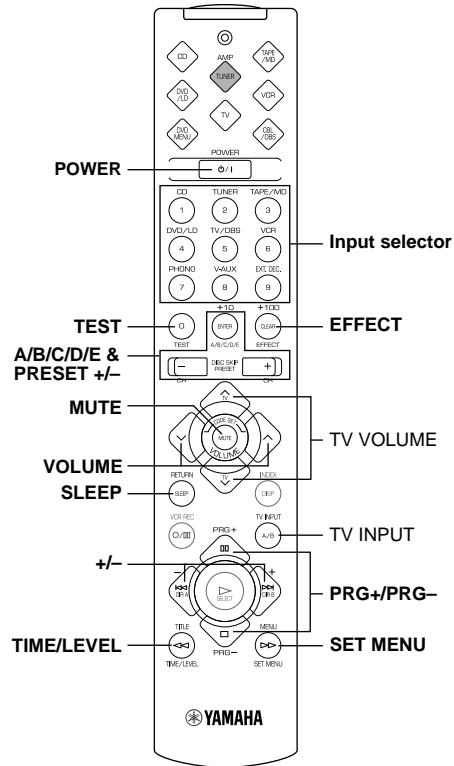

## TAPE/MD

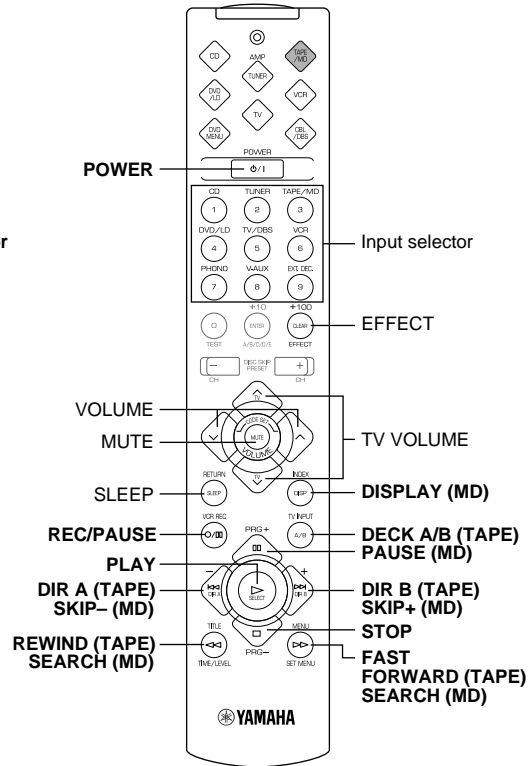

## CD

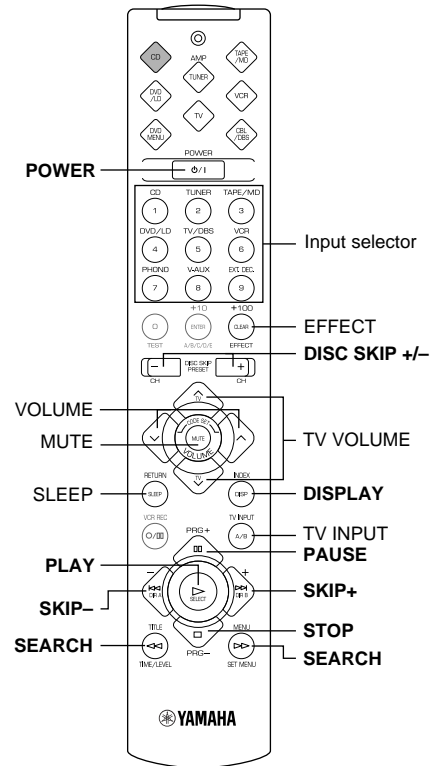

## DVD/LD

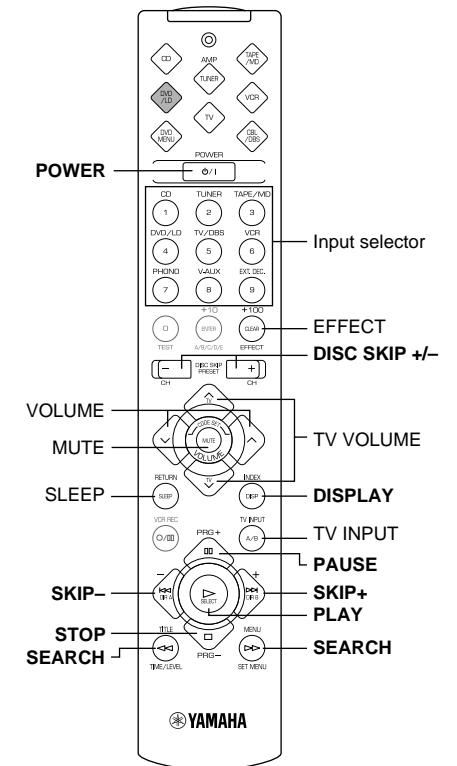

# Quick Reference Card

## DVD MENU

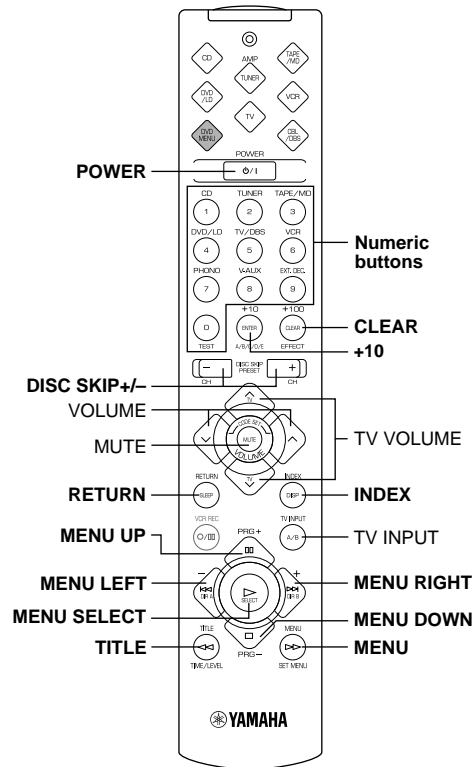

## VCR

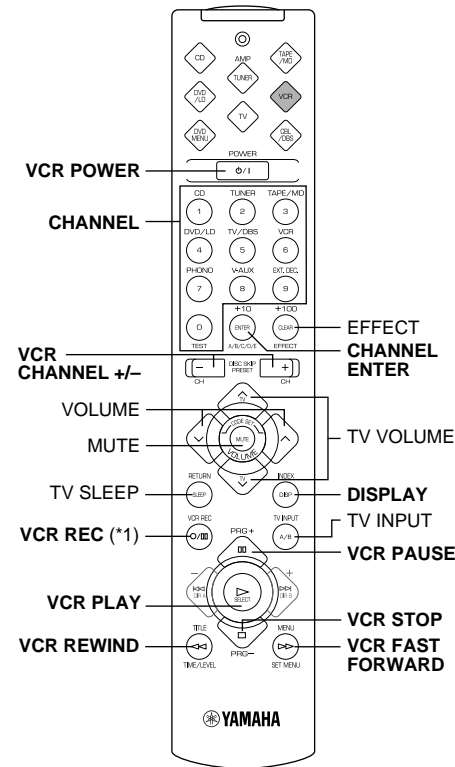

## CBL/DBS

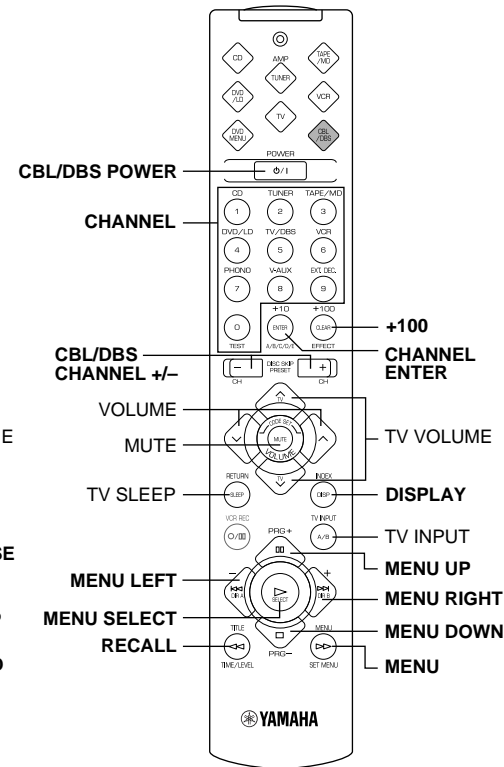

## TV

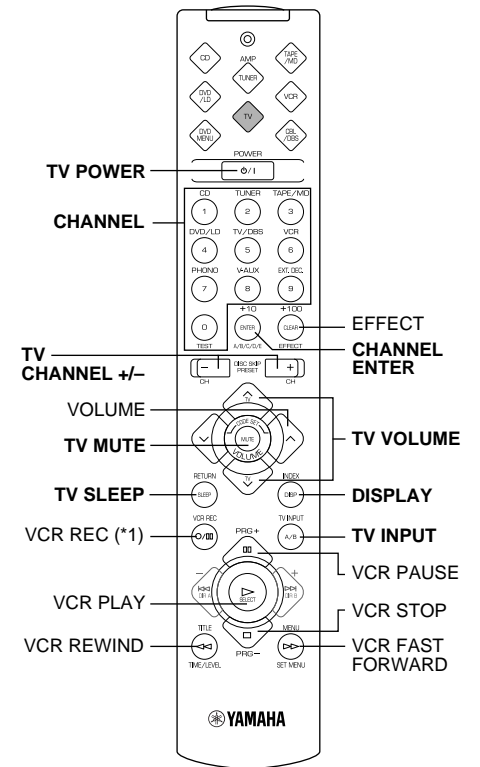

\*1: Press this button twice to start recording.  
 Appuyer deux fois sur cette touche pour lancer l'enregistrement.  
 Diese Taste zweimal drücken, um die Aufnahme zu starten.  
 Tryck två gånger på den här knappen för att börja spela in på videobandspelaren.

Premere due volte questo tasto per iniziare la registrazione.  
 Presione dos veces este botón para comenzar a grabar.  
 Druk tweemaal op deze toets om te beginnen met opnemen.  
 按两次该按钮即可开始录像。